

2005 Trail Blazer

Owner's Manual
for Maintenance and Safety



POLARIS[®]
The Way Out.

Read this manual carefully. It contains important safety information.
This is an adult vehicle only.
Operation is prohibited for those under 16 years of age.

⚠ WARNING

Improper vehicle use can result in **SEVERE INJURY** or **DEATH**.



**ALWAYS USE
AN APPROVED
HELMET AND
PROTECTIVE
GEAR**



**NEVER USE
ON PUBLIC
ROADS**



**NEVER CARRY
PASSENGERS**



**NEVER USE
WITH DRUGS
OR ALCOHOL**

NEVER:

- Operate without proper training or instruction.
- Operate on public roads. A collision can occur with another vehicle.
- Operate at speeds too fast for your skills or the conditions.
- Use **ALCOHOL** or **DRUGS** before or while operating this vehicle.
- Carry Passengers.

ALWAYS:

- Avoid paved surfaces, which may adversely affect handling and control.
- Use proper **RIDING TECHNIQUES** to avoid vehicle overturns on hills and rough terrain, and in turns.
- Wear eye protection, helmet and protective apparel.

**READ OWNER'S MANUAL.
FOLLOW ALL INSTRUCTIONS AND WARNINGS.**

Part No. 9919472 Rev 02
PRINTED IN THE USA

 **POLARIS**[®]
The Way Out.

 **WARNING**

The engine exhaust from this product contains chemicals known to cause cancer, birth defects or other reproductive harm.

A card containing important ATV safety information should be attached to the owner's manual on the next page. If you cannot locate this card, or if it has been removed, please call 1-800-342-3764 for assistance.



POLARIS

*For 50 years we've been
helping Polaris customers
find The Way Out.*

*It's been a fun ride.
But then, after all these years,
That's what we're all about.*

Find out more about our
exciting once-in-a-lifetime
50th Anniversary celebration:
Go to www.polarisindustries.com
and look for the
50th Anniversary link.

*This is a ride
you don't
want to miss!*



POLARIS
The Way Out.

Copyright 2004 Polaris Sales Inc. All information contained within this publication is based on the latest product information at the time of publication. Due to constant improvements in the design and quality of production components, some minor discrepancies may result between the actual vehicle and the information presented in this publication. Depictions and/or procedures in this publication are intended for reference use only. No liability can be accepted for omissions or inaccuracies. Any reprinting or reuse of the depictions and/or procedures contained within, whether whole or in part, is expressly prohibited.

Printed in U.S.A.

2005 Trail Blazer Owner's Manual P/N 9919472

WELCOME

Thank you for purchasing a Polaris vehicle, and welcome to our world-wide family of Polaris owners. We proudly produce an exciting line of utility and recreational products.

Polaris Recreational and Utility Vehicles

- Snowmobiles
- All-terrain vehicles (ATVs)
- Watercraft
- Victory motorcycles
- *RANGER* utility vehicles

We believe Polaris sets a standard of excellence for all utility and recreational vehicles manufactured in the world today. Many years of experience have gone into the engineering, design, and development of your Polaris vehicle, making it the finest machine we've ever produced.

For safe and enjoyable operation of your vehicle, be sure to follow the instructions and recommendations in this owner's manual. Your manual contains instructions for minor maintenance, but information about major repairs is outlined in the Polaris Service Manual and should be performed only by a Factory Certified Master Service Dealer (MSD) Technician.

Your Polaris dealer knows your vehicle best and is interested in your total satisfaction. Be sure to return to your dealership for all of your service needs during, and after, the warranty period.

We also take great pride in our Parts, Apparel and Accessories (PAA) products, available through our online store at www.purepolaris.com. Have your accessories and clothing delivered right to your door!

POLARIS and POLARIS THE WAY OUT are registered trademarks of Polaris Industries Inc.

LOCTITE is a registered trademark of LOCTITE Corporation.

TABLE OF CONTENTS

WELCOME	3
VEHICLE IDENTIFICATION NUMBERS	7
SAFETY	8
FEATURES AND CONTROLS	32
OPERATION	44
EMISSION CONTROL SYSTEMS	63
MAINTENANCE AND LUBRICATION	64
SPECIFICATIONS	103
POLARIS PRODUCTS	106
TROUBLESHOOTING	107
WARRANTY	111
INDEX	114

VEHICLE IDENTIFICATION NUMBERS

Record your ATV's identification numbers and key number in the spaces provided. Remove the spare key and store it in a safe place. Your key can be duplicated only by mating a Polaris key blank with one of your existing keys, so if both keys are lost, the ignition switch must be replaced.

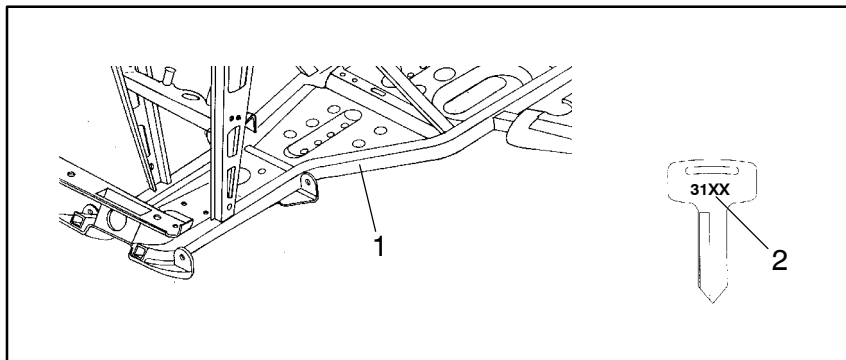

Vehicle Model Number: _____

Frame VIN (1): _____

Engine Serial Number: _____
(right front side of engine crankcase)

Key Number (2): _____

SAFETY

Operator Safety

WARNING

Failure to follow the warnings contained in this manual can result in serious injury or death.

A Polaris ATV is not a toy and can be hazardous to operate. This vehicle handles differently than other vehicles, such as motorcycles and cars. A collision or rollover can occur quickly, even during routine maneuvers like turning, or driving on hills or over obstacles, if you fail to take proper precautions.

Read and understand your owner's manual and all warnings before operating a Polaris ATV.

Age Restrictions

This vehicle is an **ADULT VEHICLE ONLY**. Operation is prohibited for anyone under 16 years of age.

Know Your Vehicle

As the operator of the vehicle, you are responsible for your personal safety, the safety of others, and the protection of our environment. Read and understand your owner's manual, which includes valuable information about all aspects of your vehicle, including safe operating procedures.

Safety Training

When you purchased your new ATV, your dealer offered a hands-on safety training course that covers all aspects of vehicle safety. You were also provided with printed materials that explain safe operating procedures. You should review this information on a regular basis.

If you purchased a used Polaris ATV from a party other than a Polaris dealer, you can request this free safety training from any authorized Polaris dealer.

A Polaris ATV is an off-road vehicle. Familiarize yourself with all laws and regulations concerning the operation of this vehicle in your area.

We strongly advise you to strictly follow the recommended maintenance program outlined in your owner's manual. This preventive maintenance program is designed to ensure that all critical components on your vehicle are thoroughly inspected at specific intervals.

Operator Safety

The following signal words and symbols appear throughout this manual and on your ATV. Your safety is involved when these words and symbols are used. Become familiar with their meanings before reading the manual.



The *safety alert symbol*, on your vehicle or in this manual, alerts you to the potential for personal injury.



WARNING

The *safety alert warning* indicates a potential hazard that may result in serious injury or death.



CAUTION

The *safety alert caution* indicates a potential hazard that may result in minor personal injury or damage to the vehicle.

CAUTION

A *caution* indicates a situation that may result in damage to the vehicle.

NOTE:

A *note* will alert you to important information or instructions.

SAFETY

Operator Safety

WARNING

Serious injury or death can result if you do not follow these instructions and procedures, which are outlined in further detail within your owner's manual.

- Read this manual and all labels carefully, and follow the operating procedures described.
- Never operate an ATV without proper instruction. *Take a training course.* Beginners should receive training from a certified instructor. Contact an authorized Polaris ATV dealer or call Polaris at 1-800-342-3764 to find out about the training courses nearest you.
- Never allow anyone under 16 years of age to operate this ATV.
- Never permit a guest to operate the ATV unless the guest has read this manual and all product labels and has completed a certified safety training course.
- Always avoid operating an ATV on paved surfaces, including sidewalks, driveways, parking lots, and streets.
- Never operate an ATV on a public street, road or highway, including a dirt or gravel road.
- Never operate an ATV without wearing an approved helmet that fits properly. Always wear eye protection (goggles or face shield), gloves, boots, a long-sleeved shirt or jacket, and long pants.
- Never consume alcohol or drugs before or while operating an ATV.
- Never operate at excessive speeds. Travel at speeds appropriate for the terrain, visibility and operating conditions, and your experience.
- Never attempt wheelies, jumps or other stunts.
- Always inspect your ATV before each use to make sure it's in safe operating condition. Always follow the inspection and maintenance procedures and schedules outlined in your owner's manual.
- Always keep both hands on the handlebars and both feet on the footrests of the ATV during operation.
- Always travel slowly and use extra caution when operating on unfamiliar terrain. Be alert to changing terrain conditions.
- Never operate on excessively rough, slippery, or loose terrain.
- Always follow proper turning procedures as described in this manual. Practice turning at low speeds before attempting to turn at faster speeds. Do not turn at excessive speeds.

Operator Safety

- Always have the ATV inspected by an authorized Polaris dealer if it's been involved in an accident.
- Never operate on hills too steep for the ATV or for your abilities. Practice on smaller hills before attempting larger hills.
- Always follow proper procedures for climbing hills. Check the terrain carefully before ascend a hill. Never climb hills with excessively slippery or loose surfaces. Shift your weight forward. Never open the throttle suddenly or make sudden gear changes. Never go over the top of a hill at high speed.
- Always follow proper procedures for going downhill and for braking on hills. Check the terrain carefully before you start down a hill. Shift your weight backward. Never go down a hill at high speed. Avoid going down a hill at an angle, which would cause the vehicle to lean sharply to one side. Travel straight down the hill when possible.
- Always follow proper procedures for crossing the side of a hill. Avoid hills with excessively slippery or loose surfaces. Shift your weight to the uphill side of the ATV. Never attempt to turn the ATV around on any hill until you've mastered (on level ground) the turning technique outlined in this manual. Avoid crossing the side of a steep hill when possible.
- Always use proper procedures if you stall or roll backwards while climbing a hill. To avoid stalling, maintain a steady speed when climbing a hill. If you stall or roll backwards, follow the special procedure for braking described in this manual. Always dismount on the uphill side, or to either side if the ATV is pointed straight uphill. Turn the ATV around and remount following the procedure described in this manual.
- Always check for obstacles before operating in a new area. Never attempt to operate over large obstacles, such as rocks or fallen trees. Always follow proper procedures when operating over obstacles as described in this manual.
- Always be careful of skidding or sliding. On slippery surfaces like ice, travel slowly and use extra caution to reduce the chance of skidding or sliding out of control.
- Avoid operating the ATV through deep or fast-flowing water. If it's unavoidable, travel slowly, balance your weight carefully, avoid sudden movements, and maintain a slow and steady forward motion. Do not make sudden turns or stops, and do not make sudden throttle changes.

SAFETY

Operator Safety

- Wet brakes may have reduced stopping ability. Test your brakes after leaving water. If necessary, apply them lightly several times to allow friction to dry out the pads.
- Always check for obstacles or people behind the ATV before operating in reverse. When it's safe to proceed in reverse, move slowly and avoid turning at sharp angles.
- Always use the size and type of tires specified for your ATV, and always maintain proper tire pressure.
- Never modify an ATV through improper installation or use of accessories.
- Never exceed the stated load capacity for your ATV. Cargo must be properly distributed and securely attached. Reduce speed and follow the instructions in this manual for carrying cargo or towing. Allow a greater distance for braking.
- Always remove the ignition key when the vehicle is not in use to prevent unauthorized use or accidental starting.

FOR MORE INFORMATION ABOUT ATV SAFETY, call the Consumer Product Safety Commission at 1-800-638-2772, or call Polaris at 1-800-342-3764.

Equipment Modifications

We are concerned for the safety of our customers and for the general public. Therefore, we strongly recommend that consumers do not install on a Polaris ATV any equipment that may increase the speed or power of the vehicle, or make any other modifications to the vehicle for these purposes. Any modifications to the original equipment of the vehicle create a substantial safety hazard and increase the risk of bodily injury.

The warranty on your Polaris ATV is terminated if any equipment has been added to the vehicle, or if any modifications have been made to the vehicle, that increase its speed or power.

NOTE: The addition of certain accessories, including (but not limited to) mowers, blades, tires, sprayers, or large racks, may change the handling characteristics of the vehicle. Use only Polaris-approved accessories, and familiarize yourself with their function and effect on the vehicle.

Operator Safety

WARNING

POTENTIAL HAZARD

Operating this ATV without proper instruction.

WHAT CAN HAPPEN

The risk of an accident is greatly increased if the operator does not know how to operate the ATV properly in different situations and on different types of terrain.

HOW TO AVOID THE HAZARD

Beginning and inexperienced operators should complete the certified training course offered by Polaris. Operators should regularly practice the skills learned in the course and the operating techniques described in the owner's manual.

For more information about the training course, contact an authorized ATV dealer or call Polaris at 1-800-342-3764.

WARNING

POTENTIAL HAZARD

Failure to follow the age recommendations for this ATV.

WHAT CAN HAPPEN

Severe injury and/or death could occur if a child under the minimum age recommendation operates an ATV.

Even though a child may be within the recommended age group for operating some ATVs, he/she may not have the skills, abilities, or judgment needed to operate an ATV safely and could be susceptible to accident or injury.

HOW TO AVOID THE HAZARD

No one under the age of 16 should operate a Polaris ATV.

SAFETY

Operator Safety

⚠ WARNING

POTENTIAL HAZARD

Carrying a passenger on an ATV.

WHAT CAN HAPPEN

Carrying a passenger greatly reduces the operator's ability to balance and control the ATV, which could cause an accident and injury to the operator and/or passenger.

HOW TO AVOID THE HAZARD

Never carry a passenger. The purpose of the long seat is to allow the operator to shift position as needed during operation. It is not intended for carrying passengers.

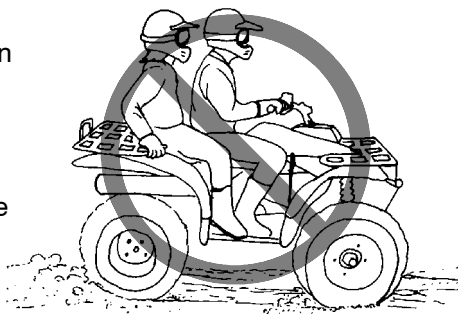

⚠ WARNING

POTENTIAL HAZARD

Operating an ATV on paved surfaces, including sidewalks, paths, parking lots, and driveways.

WHAT CAN HAPPEN

ATV tires are designed for off-road use. Operating on paved surfaces may seriously affect the handling and control of the ATV and could result in loss of control, accident, and/or injury.

HOW TO AVOID THE HAZARD

Avoid operating the ATV on pavement. If it's unavoidable, travel slowly and avoid sudden turns or stops.



Operator Safety

⚠ WARNING

POTENTIAL HAZARD

Operating this ATV on public streets, roads or highways.

WHAT CAN HAPPEN

The ATV could collide with another vehicle.

HOW TO AVOID THE HAZARD

Never operate the ATV on any public street, road or highway, including dirt and gravel roads. In many states it's illegal to operate ATVs on public streets, roads and highways.

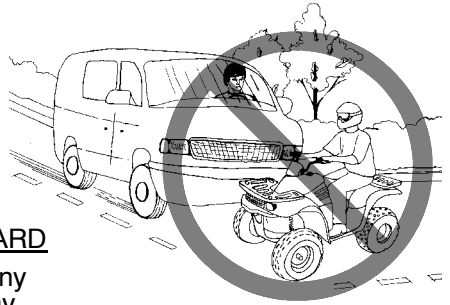

⚠ WARNING

POTENTIAL HAZARD

Operating this ATV without wearing an approved helmet, eye protection and protective clothing.

WHAT CAN HAPPEN

Operating an ATV without an approved helmet increases the risk of a severe head injury or death in the event of an accident.

Operating without eye protection could result in an accident and could increase the chance of a severe injury in the event of an accident.

HOW TO AVOID THE HAZARD

Always wear an approved helmet that fits properly.

Always wear eye protection (goggles or face shield), gloves, boots, long-sleeved shirt or jacket, and long pants.



SAFETY

Operator Safety

⚠ WARNING

POTENTIAL HAZARD

Operating the ATV after consuming alcohol or drugs.

WHAT CAN HAPPEN

Consumption of alcohol and/or drugs could seriously affect operator judgment. Reaction time may be slower and operator balance and perception could be affected.

Consuming alcohol and/or drugs before or while operating an ATV could result in an accident causing severe injury or death.

HOW TO AVOID THE HAZARD

Never consume alcohol or drugs before or while operating an ATV.



⚠ WARNING

POTENTIAL HAZARD

Operating the ATV at excessive speeds.

WHAT CAN HAPPEN

Excessive speed increases the operator's chance of losing control of the ATV, which can result in an accident.

HOW TO AVOID THE HAZARD

Always operate the ATV at a speed that's proper for the terrain, visibility and operating conditions, and your experience.

Operator Safety

⚠ WARNING

POTENTIAL HAZARD

Attempting wheelies, jumps and other stunts.

WHAT CAN HAPPEN

Attempting stunts increases the chance of an accident, including an overturn.

HOW TO AVOID THE HAZARD

Never attempt wheelies, jumps, or other stunts. Avoid exhibition driving.

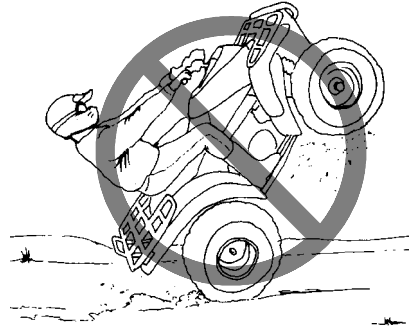

⚠ WARNING

POTENTIAL HAZARD

Failure to inspect the ATV before operating.

Failure to properly maintain the ATV.

WHAT CAN HAPPEN

Poor maintenance increases the possibility of an accident or equipment damage.

HOW TO AVOID THE HAZARD

Always inspect your ATV before each use to make sure it's in safe operating condition.

Always follow the inspection and maintenance procedures and schedules described in the owner's manual.

SAFETY

Operator Safety

⚠ WARNING

POTENTIAL HAZARD

Removing hands from the handlebars or feet from the footrests during operation.

WHAT CAN HAPPEN

Removing even one hand or foot can reduce ability to control the vehicle or could cause loss of balance and ejection from the ATV.

If the operator's foot is not firmly planted on the footrest, it could come into contact with the rear wheels and lead to accident or injury.

HOW TO AVOID THE HAZARD

Always keep both hands on the handlebars and both feet on the footrests of the ATV during operation.

⚠ WARNING

POTENTIAL HAZARD

Failure to use extra caution when operating the ATV on unfamiliar terrain.

WHAT CAN HAPPEN

Unfamiliar terrain may contain hidden rocks, bumps, or holes that could cause loss of control or overturn.

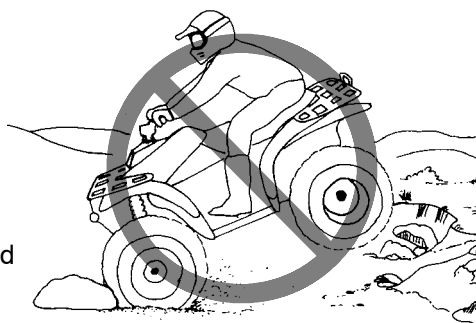

HOW TO AVOID THE HAZARD

Travel slowly and use extra caution when operating on unfamiliar terrain. Always be alert to changing terrain conditions.

Operator Safety

⚠️ WARNING

POTENTIAL HAZARD

Failure to use extra caution when operating on excessively rough, slippery or loose terrain.

WHAT CAN HAPPEN

Operating on excessively rough, slippery or loose terrain could cause loss of traction or loss of control, which could result in an accident or overturn.

HOW TO AVOID THE HAZARD

Do not operate on excessively rough, slippery or loose terrain until you've learned and practiced the skills necessary to control the ATV on such terrain.

Always use extra caution on rough, slippery or loose terrain.

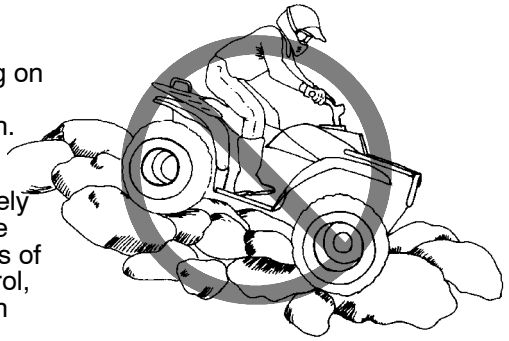

⚠️ WARNING

POTENTIAL HAZARD

Turning improperly.

WHAT CAN HAPPEN

Improper turns could cause loss of control and lead to a collision or overturn.

HOW TO AVOID THE HAZARD

Always follow proper procedures for turning as described in the owner's manual.

Practice turning at slow speeds before attempting to turn at faster speeds.

Never turn at excessive speed.

SAFETY

Operator Safety

⚠ WARNING

POTENTIAL HAZARD

Operating on excessively steep hills.

WHAT CAN HAPPEN

The vehicle may overturn.

HOW TO AVOID THE HAZARD

Never operate on hills too steep for the ATV or for your abilities. Never operate the ATV on hills steeper than 25°.

Practice on smaller hills before attempting large hills.

⚠ WARNING

POTENTIAL HAZARD

Climbing hills improperly.

WHAT CAN HAPPEN

Improper hill climbing could cause loss of control or overturn.

HOW TO AVOID THE HAZARD

Always follow proper procedures for climbing hills as described in the owner's manual.

Always check the terrain carefully before ascending any hill.

Never operate the ATV on hills steeper than 25°.

Never climb hills with excessively slippery or loose surfaces.

Shift your weight forward.

Never open the throttle suddenly while traveling uphill. The ATV could flip over backwards.

Never go over the top of any hill at high speed. An obstacle, a sharp drop, or another vehicle or person could be on the other side of the hill.

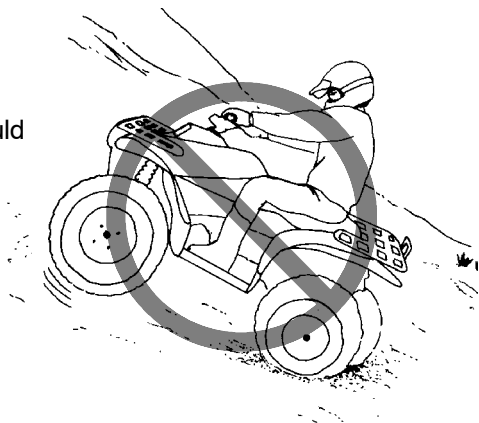

Operator Safety

⚠ WARNING

POTENTIAL HAZARD

Traveling downhill improperly.

WHAT CAN HAPPEN

Improperly descending a hill could cause loss of control or overturn.

HOW TO AVOID THE HAZARD

Always follow proper procedures for traveling down hills as described in the owner's manual.

NOTE: A special technique is required when braking while traveling downhill. See page 54.

Always check the terrain carefully before descending a hill.

Shift your weight backward.

Never travel down a hill at high speed.

Avoid traveling down a hill at an angle, which would cause the vehicle to lean sharply to one side. Travel straight down the hill when possible.

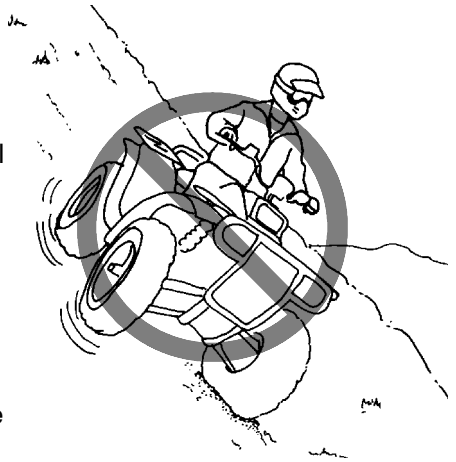

SAFETY

Operator Safety

⚠ WARNING

POTENTIAL HAZARD

Improperly crossing hills and turning on hills.

WHAT CAN HAPPEN

Improperly crossing or turning as hills could cause loss of control or overturn.

HOW TO AVOID THE HAZARD

Never attempt to turn the ATV around on any hill until you've mastered the turning technique (on level ground) as described in the owner's manual. See page 55. Use extra caution when turning on any hill.

Avoid crossing the side of a steep hill.

When crossing the side of a hill:

Always follow proper procedures as described in the owner's manual.

Avoid hills with excessively slippery or loose surfaces.

Shift your weight to the uphill side of the ATV.



Operator Safety

⚠ WARNING

POTENTIAL HAZARD

Stalling, rolling backwards or improperly dismounting while climbing a hill.

WHAT CAN HAPPEN

The vehicle could overturn.

HOW TO AVOID THE HAZARD

Maintain steady speed when climbing a hill.

If all forward speed is lost:

Keep your weight uphill.

Apply the single lever brake gradually.

When fully stopped, apply the auxiliary rear brake as well, then lock the parking brake.

If the ATV begins rolling backwards:

Keep weight uphill.

Never apply engine power.

Never apply the auxiliary rear brake while rolling backwards.

Apply the single-lever brake gradually.

When fully stopped, apply the auxiliary rear brake as well, and then lock the parking brake.

Dismount on uphill side, or to either side if ATV is pointed straight uphill.

Turn the ATV around and remount, following the procedure described in the owner's manual. See page 55.



SAFETY

Operator Safety

WARNING

POTENTIAL HAZARD

Improperly operating over obstacles.

WHAT CAN HAPPEN

Operating over obstacles could cause loss of control or overturn.

HOW TO AVOID THE HAZARD

Before operating in a new area, check for obstacles.

Avoid operating over large obstacles such as rocks and fallen trees when possible. If unavoidable, use extreme caution and always follow proper procedures as outlined in the owner's manual.

WARNING

POTENTIAL HAZARD

Skidding or sliding.

WHAT CAN HAPPEN

Skidding or sliding can cause loss of control.

If the tires regain traction unexpectedly, the ATV could overturn.

HOW TO AVOID THE HAZARD

On slippery surfaces such as ice, travel slowly and use extra caution to reduce the chance of skidding or sliding out of control.

WARNING

POTENTIAL HAZARD

Improperly operating in reverse.

WHAT CAN HAPPEN

The ATV could collide with an obstacle or person, resulting in severe injury.

HOW TO AVOID THE HAZARD

Before shifting into reverse gear, always check for obstacles or people behind the ATV. When it's safe to proceed, back slowly.

Operator Safety

WARNING

POTENTIAL HAZARD

Operating the ATV through deep or fast-flowing water.

WHAT CAN HAPPEN

Tires may float, causing loss of traction and loss of control, which could lead to an accident or overturn.

HOW TO AVOID THE HAZARD

Avoid operating the ATV through deep or fast-flowing water. If it's unavoidable to enter water that exceeds the recommended maximum depth (see page 56), travel slowly, balance your weight carefully, avoid sudden movements, and maintain a slow and steady forward motion. Do not make sudden turns or stops, and do not make sudden throttle changes.

Wet brakes may have reduced stopping ability. Always test the brakes after leaving water. If necessary, apply them several times to let friction dry out the pads.

WARNING

POTENTIAL HAZARD

Operating this ATV with improper tires, or with improper or uneven tire pressure.

WHAT CAN HAPPEN

Use of improper tires, or operation of the ATV with improper or uneven tire pressure, could cause loss of control or accident.

HOW TO AVOID THE HAZARD

Always use the size and type of tires specified for the ATV.

Always maintain proper tire pressure as specified.

SAFETY

Operator Safety

WARNING

POTENTIAL HAZARD

Operating the ATV with improper modifications.

WHAT CAN HAPPEN

Improper installation of accessories or modification of the ATV may cause changes in handling which could lead to an accident.

HOW TO AVOID THE HAZARD

Never modify the ATV through improper installation or use of accessories. All parts and accessories added to the vehicle must be genuine Polaris Industries Inc. or equivalent components designed for use on this ATV and should be installed and used according to approved instructions. See your authorized Polaris ATV dealer for more information.

WARNING

POTENTIAL HAZARD

Overloading the ATV or carrying/towing cargo improperly.

WHAT CAN HAPPEN

Overloading and towing can cause changes in vehicle handling, which could lead to loss of control or an accident.

HOW TO AVOID THE HAZARD

Never exceed the stated load capacity for this ATV.

Cargo should be properly distributed and securely attached.

Reduce speed when carrying cargo or pulling a trailer. Allow a greater distance for braking.

Always follow the instructions in the owner's manual for carrying cargo or pulling a trailer. See page 60.

WARNING

POTENTIAL HAZARD

Operating on frozen bodies of water.

WHAT CAN HAPPEN

Severe injury or death can result if the ATV and/or the operator fall through the ice.

HOW TO AVOID THE HAZARD

Never operate the ATV on a frozen body of water.

Operator Safety

WARNING

Leaving the keys in the ignition can lead to unauthorized use of the vehicle resulting in serious injury or death. Always remove the ignition key when the vehicle is not in use.

WARNING

After any overturn or accident, have a qualified service dealer inspect the entire vehicle for possible damage, including (but not limited to) brakes, throttle and steering systems.

WARNING

Safe operation of this rider-active vehicle requires good judgement and physical skills. Persons with cognitive or physical disabilities who operate this vehicle have an increased risk of overturn and loss of control, which could result in severe injury or death.

CAUTION

Always keep combustible materials away from the exhaust system. Exposure to the hot components could result in a fire.

SAFETY

Safety Decals and Locations

Warning decals have been placed on the ATV for your protection. Read and follow the instructions of the decals and other warnings on the ATV carefully. If any of the decals shown in this manual differ from the decals on your ATV, always read and follow the instructions of the decals *on the ATV*.

If any decal becomes illegible or comes off, contact your Polaris dealer to purchase a replacement. Replacement *safety* decals are provided by Polaris at no charge. The part number is printed on the decal.

⚠️ WARNING

- Never operate this vehicle on HILLS steeper than 25 degrees $\angle 25^\circ$. To prevent flipover on hilly terrain, when going up or down, use throttle and brakes gradually.
- REVERSE operation can be dangerous, even at low speeds. Steering becomes difficult. To prevent flipover, avoid sudden braking or sharp turns.
- Use OVERRIDE for reverse speed limiter with caution. To prevent loss of control, never activate override button with open throttle.
- PARKING BRAKE may relax when used for more than 5 minutes. When parking on grades, leave shift in forward.

7172665

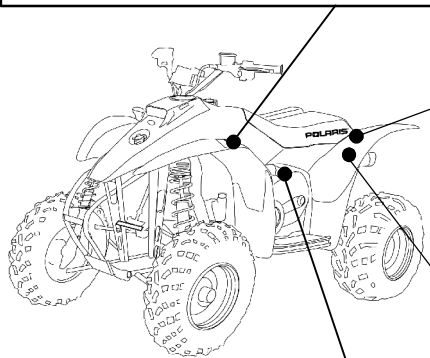

⚠️ WARNING

NEVER ride as a passenger



Passengers can cause a loss of control, resulting in SEVERE INJURY or DEATH

7172566

⚠️ WARNING

IMPROPER TIRE PRESSURE OR OVERLOADING can cause loss of control resulting in SEVERE INJURY OR DEATH.

TIRE PRESSURE IN PSI (kPa): FRONT 4 (27.6) REAR 3 (20.7)

MAXIMUM WEIGHT CAPACITY (Gross Vehicle Weight)

INCLUDING MACHINE, DRIVER AND CARGO IS 785 LBS. (348 kg)

Reduce speed and allow greater distance for braking when carrying cargo. Overloading or carrying tall, off-center, or unsecured loads will increase your risk of losing control. Loads should be centered, carried as low as possible, and firmly secured to the racks. With dual racks, load distribution 1/3 front 2/3 rear is best. For stability on rough or hilly terrain, reduce speed and cargo. Do not block headlight. Be careful if load extends over the side of the rack.

Read Owner's Manual for more detailed loading information.

7172664

⚠️ WARNING

- Moving parts hazard under belt-clutch guard. To prevent serious injury, do not operate vehicle with guard removed.
- Do not modify engine or clutch. Doing so can cause part failure, possible imbalance, and excessive engine RPM, which can result in serious injury or death.

NO STEP

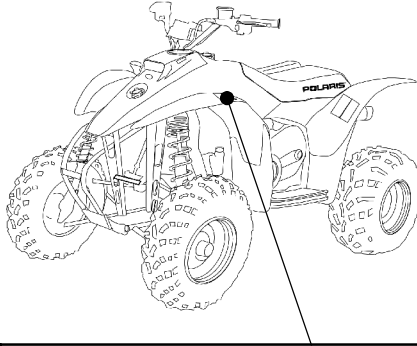

7172563

Safety Decals and Locations



⚠ WARNING

Improper ATV use can result in SEVERE INJURY or DEATH

			
ALWAYS USE AN APPROVED HELMET AND PROTECTIVE GEAR	NEVER USE ON PUBLIC ROADS	NEVER CARRY PASSENGERS	NEVER USE WITH DRUGS OR ALCOHOL

NEVER operate:

- without proper training or instruction
- at speeds too fast for your skills or the conditions
- on public roads - a collision can occur with another vehicle
- with a passenger - passengers affect balance and steering and increase risk of losing control

ALWAYS:

- use proper riding techniques to avoid vehicle overturns on hills and rough terrain and in turns
- avoid paved surfaces - pavement may seriously affect handling and control

**LOCATE AND READ OWNER'S MANUAL.
FOLLOW ALL INSTRUCTIONS AND WARNINGS.**

**IF OWNER'S MANUAL IS MISSING, CONTACT
A POLARIS DEALER FOR A REPLACEMENT.**

© 1997, 2000 7172560

SAFETY

Safety Decals and Locations



⚠ WARNING



Operating this ATV if you are under the age of 16 increases your chance of severe injury or death.

NEVER operate this ATV if you are under age 16.

7172559

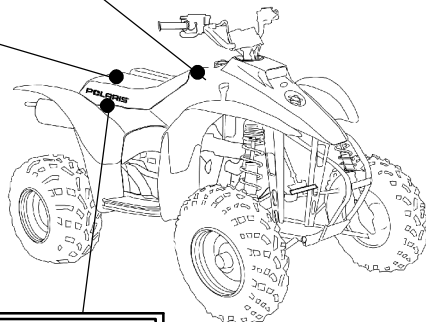

Under Seat

<ul style="list-style-type: none"> • Operation of this vehicle without the filter element will severely damage the engine. • Clean air filter often, more frequent cleaning required in dusty conditions. 	ATTENTION	<ul style="list-style-type: none"> • Specific carburetor jetting and adjustments are required depending on temperature and altitude. See your Owner's Manual. Factory setting: 40° to 80° F. at 0-3000 feet. (5° to 27° C. at 0-900 meters).
-----------------------------------------------------------------------------------------------------------------------------------------------------------------------------------------------------------------------------------	------------------	-------------------------------------------------------------------------------------------------------------------------------------------------------------------------------------------------------------------------------------------------------------

7079801

RH Swingarm

Chain Freeplay Is Important. Adjust Freeplay to 3/16" - 3/8" DO NOT Overtension. See Owner's Manual.

Torque Nut on Eccentric Bolts:
To 30 Ft. Lbs. (For models without a hitch).
To 40 Ft. Lbs. (For models with a hitch).

7078572



MANUFACTURED BY: POLARIS IND. INC.

DATE:

VIN:

THIS VEHICLE IS AN ALL TERRAIN VEHICLE AND IS NOT INTENDED FOR USE ON PUBLIC ROADS.

CE VÉHICULE EST UN VÉHICULE TOUT TERRAIN QUI N'EST PAS DESTINÉ À ÊTRE UTILISÉ SUR LES CHEMINS PUBLICS.

PATENT NOTICE Mfd. by All Terrain Vehicle Division, Polaris Industries Inc. under one or more of the following patents: Other patents pending, U.S. Patents

4697665	5036939	5975624
6016943	6092877	6149540
6224134	6270106	6340186
D378080	D389440	D400143



7171492

VERRIDE SWITCH

Reverse Speed is limited.

Reverse override is controlled by the override switch.

See your Owner's Manual.

7079906

Canadian Certification Decal

Safe Riding Gear

Always wear clothing suited to the type of riding. ATV riding requires special protective clothing for comfort and to reduce the chance of injury.

1. Helmet

Your helmet is the most important piece of protective gear for safe riding. A helmet can prevent a severe head injury.

Select an approved helmet that meets or exceeds your state's safety standards and bears either the Department of Transportation (DOT) label, the American National Standards Institute label (ANSI z90.1), or the Snell Memorial Foundation label.

2. Eye Protection

Do not depend on sunglasses for proper eye protection. A pair of goggles or a helmet face shield offer the best protection for your eyes. They should be kept clean and be of shatterproof design (bearing the markings z2.1 or VESC 8).

3. Gloves

Off-road style gloves with knuckle pads are the best for comfort and protection.

4. Boots

The best footwear is a pair of strong over-the-calf boots with heels, like moto-cross boots.

5. Clothing

Always wear long sleeves and long pants to protect arms and legs. Riding pants with kneepads and a jersey with shoulder pads provide the best protection.

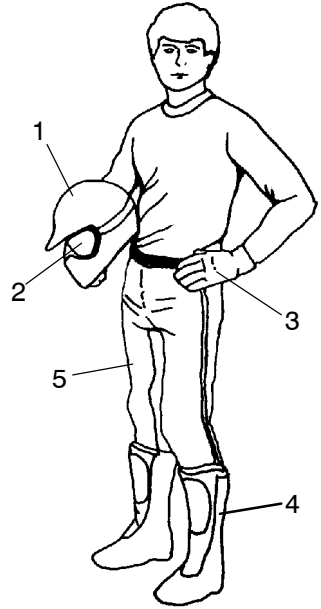

FEATURES AND CONTROLS

Electrical Switches

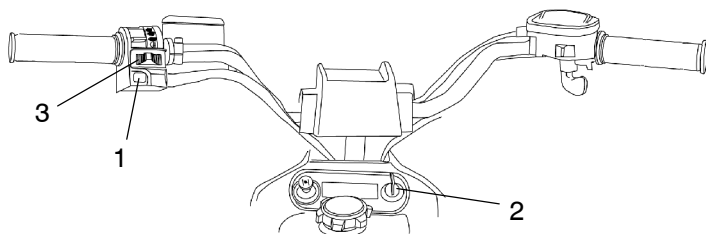

⚠ WARNING

Activating the override switch while the throttle is open can cause loss of control, resulting in severe injury or death. Do not activate the override switch while the throttle is open.

Override Switch (1) (Reverse Speed Limiter) - This vehicle is equipped with a reverse speed limiter system. To gain additional power while backing, depress the override switch.

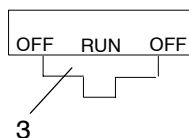

Main Switch (2) - To start the engine, slide the stop switch to the center RUN position and turn the main key switch clockwise past the ON position. Release the key when the engine starts.

NOTE: Turning off the main switch will shut off all electrical power to the vehicle, including the lights.

⚠ WARNING

Leaving the keys in the ignition can lead to unauthorized use of the vehicle resulting in serious injury or death. Always remove the ignition key when the vehicle is not in use.

Engine Stop Switch (3) - The engine will not start or run when the switch is in its OFF position. Its purpose is to provide the operator with a quick means of engine shutdown in case of an emergency. To stop the engine, slide the stop switch either right or left to the OFF position.

NOTE: Turning off the engine stop switch will shut off all electrical power to the vehicle, including the lights.

FEATURES AND CONTROLS

⚠ WARNING

Do not start or operate an ATV with sticking or improperly operating throttle controls, which could cause an accident and lead to severe injury or death.

Always contact your dealer for service repairs if throttle problems arise.

Failure to check or maintain proper operation of the throttle system can result in an accident if the throttle lever sticks during operation.

Always check the lever for free movement and return before starting the engine. Also check occasionally during operation.

Throttle Lever

Engine speed and vehicle movement are controlled by pressing the throttle lever. The throttle lever (1) is spring loaded. Engine speed returns to idle when the lever is released.

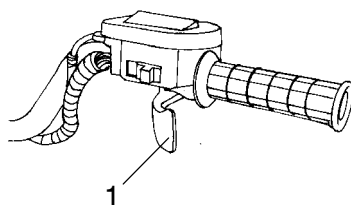

This ATV is equipped with Polaris Electronic Throttle Control (ETC), which is designed to reduce the risk of a frozen or stuck throttle. If the throttle cable should stick in an open position when the operator releases the throttle lever, the engine will stop, and power to the rear wheels will cease.

⚠ WARNING

The Electronic Throttle Control (ETC) stops the engine in the event of a throttle system malfunction and is provided for your safety. Do not attempt to modify the ETC system or replace it with any after market throttle mechanisms.

FEATURES AND CONTROLS

⚠ WARNING

Operating the ATV on streets or roads, especially in darkness, could result in an accident and serious injury or death.

Your ATV is not equipped with highway-approved lights. It's designed for and must be used for *off-road use only*. Use caution and drive at reduced speeds in conditions of reduced visibility such as fog, rain and darkness.

Light Switches

The light switch is located on the left handlebar (1). It's used to turn the lights on and off.

NOTE: The lights won't work unless the key is in the ON position and the shut-off switch is in the RUN position.

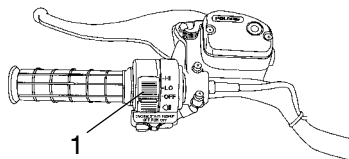

Indicator Lights

With the engine running, verify the function of all indicator lights each time the ATV is used.

NOTE: The taillight is on whenever the main switch (key) is on. Turn the key off to prevent battery drain.

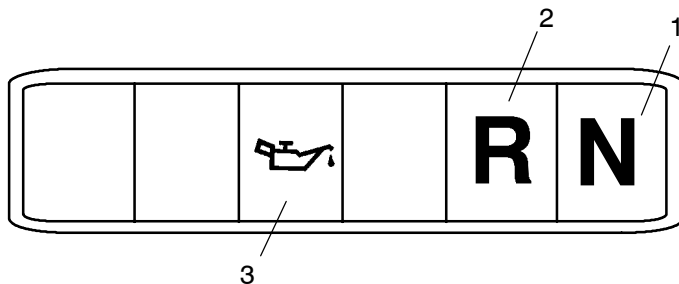

- 1. Transmission Neutral Indicator**
- 2. Transmission Reverse Indicator**
- 3. Oil Warning** (indicates a low oil level).

FEATURES AND CONTROLS

Brakes

Check the brake fluid level in the master cylinder before each use of the ATV. The master cylinder (1) is located on the left handlebar.

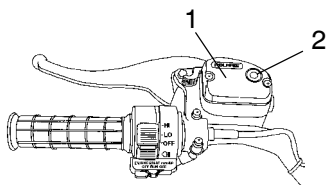

1. Position the ATV on level ground with the handlebars straight.
2. View the fluid level through the indicator window (2) on the top of the master cylinder. This “eye” will appear dark when the fluid level is full. When fluid needs to be added, the eye will be clear.

WARNING

An over-full master cylinder may cause brake drag or brake lock-up, which could result in serious injury or death. Maintain brake fluid at the recommended level. Do not overfill.

NOTE: Under normal operation, the diaphragm extends into the reservoir as fluid level drops. If the fluid level is low and the diaphragm is not extended, a leak is likely and the diaphragm should be replaced. Always fill the reservoir as needed whenever the cover is loosened or removed to ensure proper diaphragm operation. We recommend the use of Polaris DOT 3 brake fluid. Do not overfill.

3. If the fluid level is low, add DOT 3 brake fluid only. See page 106 for the part numbers of Polaris products.

WARNING

Never store or use a partial bottle of brake fluid. Brake fluid is hygroscopic, meaning it rapidly absorbs moisture from the air. The moisture causes the boiling temperature of the brake fluid to drop, which can lead to early brake fade and the possibility of accident or severe injury. After opening a bottle of brake fluid, always discard any unused portion.

FEATURES AND CONTROLS

Brake Lever

The front and rear brakes are applied by squeezing the brake lever (1) toward the handlebar. The front and rear brakes are hydraulically activated disc type brakes that are activated by only one lever.

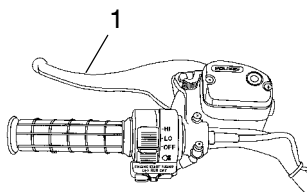

Always test brake lever travel and master cylinder fluid level before riding. When squeezed, the lever should feel firm. Any sponginess would indicate a possible fluid leak or low master cylinder fluid level, which must be corrected before riding. Contact your dealer for proper diagnosis and repairs.

WARNING

Operating the ATV with a spongy brake lever can result in loss of braking, which could cause an accident. Never operate the ATV with a spongy-feeling brake lever.

FEATURES AND CONTROLS

Parking Brake

⚠ WARNING

Operating the ATV while the parking brake is engaged could result in an accident and serious injury or death. Always check to be sure the parking brake is disengaged before operating.

Setting the Parking Brake

1. Squeeze and release the brake lever (1) two or three times, then squeeze and hold.
2. Push the park brake lock (2) forward to engage the brake. Release the brake lever.
3. To release the parking brake lock, squeeze and release the brake lever. It will return to its unlocked position.

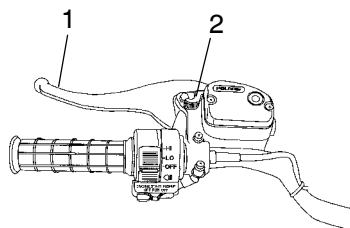

Important Safeguards

- The parking brake may relax if left on for a long period of time. Always block the wheels to prevent rolling.
- Always block the wheels on the downhill side of the ATV if leaving it parked on a hill. Another option is to park the ATV in a sidehill position.
- Never depend on the parking brake alone if the ATV is parked on a hill. Always block the wheels to prevent rolling.

FEATURES AND CONTROLS

Auxiliary Brake

⚠ WARNING

Aggressively applying the rear brake when backing downhill may cause rear tipover, which could result in serious injury or death.

Use caution when applying the auxiliary brake. Do not aggressively apply the auxiliary brake when going forward. The rear wheels may skid and slide sideways, causing loss of control and serious injury or death.

The auxiliary brake (1), is located on the inside of the right floor board and is operated by the right foot. The auxiliary brake serves as a backup to the main brake system if the main system becomes inoperative.

If the rear wheels slide while using the auxiliary brake, *reduce* brake pedal pressure to brake the rear wheels without skidding.

Check the brake fluid level frequently for the auxiliary brake system. The reservoir is located under the seat or near the foot brake. Maintain the fluid level between the maximum and minimum marks.

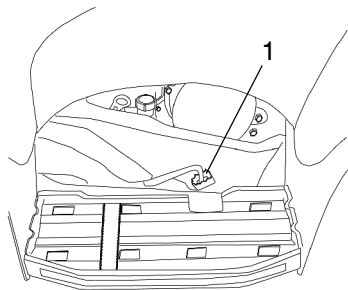

FEATURES AND CONTROLS

Choke

The choke assists in starting a cold engine. Refer to the engine starting procedure on page 47 for correct choke and throttle settings during starting.

Fuel Valve

The fuel valve (1) is located on the left side of the vehicle, below the fender. It has three positions:

OFF: For vehicle storage and when transporting.

ON: For normal operation.

RES: For reserve supply if main supply is exhausted.

NOTE: There's about a 7 to 10 mile (11.2 reserve gas. Always refill the gas after using the reserve supply.

Always return valve to ON position after refueling.

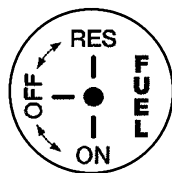

Fuel Tank

The fuel tank filler cap (2) is located directly below the handlebar. Use either leaded or unleaded gasoline with a minimum pump octane number of $87=(R+ M/2)$ octane. Refer to the specifications section beginning on page 103 for capacities.

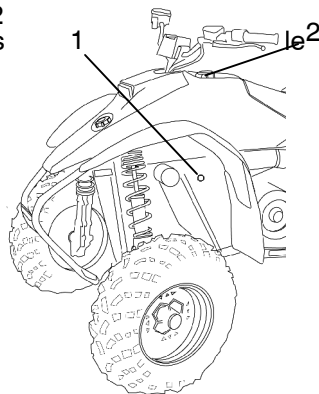

Fuel Filter

Replace the in-line fuel filter at the intervals outlined in the Periodic Maintenance Chart beginning on page 65. Do not attempt to clean the fuel filter.

FEATURES AND CONTROLS

Fuel Safety

WARNING

Gasoline is highly flammable and explosive under certain conditions.

- Always exercise extreme caution whenever handling gasoline.
- Always refuel with the engine stopped, and outdoors or in a well ventilated area.
- Do not smoke or allow open flames or sparks in or near the area where refueling is performed or where gasoline is stored.
- Do not overfill the tank. Do not fill the tank neck.
- If gasoline spills on your skin or clothing, immediately wash it off with soap and water and change clothing.
- Never start the engine or let it run in an enclosed area. Engine exhaust fumes are poisonous and can cause loss of consciousness or death in a short time.
- Turn the fuel valve off whenever the ATV is stored or parked.

WARNING

The engine exhaust from this product contains chemicals known to cause cancer, birth defects or other reproductive harm.

Operate this vehicle only outdoors or in well-ventilated areas.

FEATURES AND CONTROLS

Oil Injection Tank

CAUTION

Mixing brands or using a non-recommended oil may cause serious engine damage. We recommend the use of Polaris Premium Synthetic 2-cycle oil for your 2-cycle Polaris ATV. Never substitute or mix oil brands.

To avoid serious engine damage, always top off the oil level when refueling.

The oil injection tank filler cap (1) is located on the front of the vehicle. Refer to the specifications section beginning on page 103 for capacities.

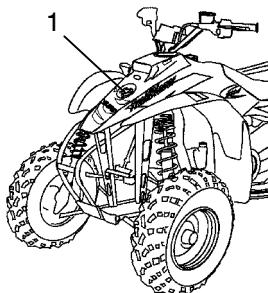

FEATURES AND CONTROLS

Automatic Transmission Gear Selector

The transmission gear selector (1) is located on the right side of the ATV.

F: Forward

N: Neutral

R: Reverse

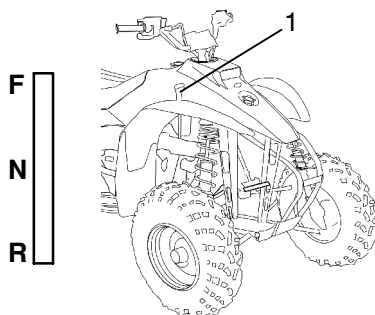

CAUTION

Shifting gears with the engine speed above idle or while the vehicle is moving could cause transmission damage.

To change gears, stop the vehicle, and with the engine idling, move the lever to the desired gear.

Whenever the ATV is left unattended, always place the transmission in gear and lock the parking brake.

FEATURES AND CONTROLS

Recoil Starter

If the battery has been drained or damaged and cannot start the engine, use of the recoil starter (1) will allow vehicle operation until repairs can be made. The recoil starter is located on the right side of the machine.

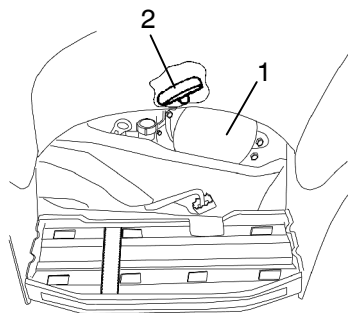

1. Position the vehicle on a level surface and lock the parking brake (see page 37).
2. Shift the transmission into neutral.
3. Make sure the engine stop switch is set to RUN and the main key switch is in the ON position.

NOTE: If the engine is cold, use the choke as outlined on page 47.

4. Reach under the side panel and grasp the starter rope handle (2) firmly and pull slowly so you can feel the engine strokes.

NOTE: Every other stroke will be a “compression stroke” and will make the rope harder to pull. When a compression stroke is found, continue pulling the rope just until the engine rolls past the stroke, then *stop pulling immediately*.

5. Allow the recoil rope to rewind into the recoil assembly, then pull the rope abruptly and forcefully to start the engine.
6. Repeat steps 4-5 if necessary.

CAUTION

Extending the recoil starter rope until it stops can cause damage to the recoil assembly. Do not extend the starter rope so far that it stops.

If the starter rope handle is not seated properly, water may enter the recoil housing and damage components. Make sure the handle is fully seated on the recoil housing, especially when traveling in wet areas.

OPERATION

Break-In Period

The break-in period for your new Polaris ATV is defined as the time it takes to use the first tank of fuel. No single action on your part is as important as following the procedures for a proper break-in. Careful treatment of a new engine will result in more efficient performance and longer life for the engine. Perform the following procedures carefully.

CAUTION

Excessive heat build-up during the first three hours of operation will damage close-fitted engine parts. Do not operate at full throttle or high speeds for extended periods during the first three hours of use.

Use of any oils other than those recommended by Polaris may cause serious engine damage. We recommend the use of Polaris 2-cycle oil for your 2-cycle engine.

Lack of proper lubrication will cause serious engine damage. Always fill the oil tank when refueling the ATV.

Break-In Period

The first tank of fuel must be pre-mixed according to the following instructions. After the break-in period, the oil injection system will provide the necessary engine lubrication without pre-mixing.

1. Premix the recommended oil with gasoline in a suitable gas container. Refer to the chart below for ratios.
2. Fill the fuel tank (see page 39), then fill the oil tank with the recommended oil.
3. Drive slowly at first. Vary the throttle positions.
4. Perform regular checks on fluid levels, controls, and areas outlined on the daily pre-ride inspection checklist on page 46.

After the first tank of pre-mixed fuel has been used, verify that the oil level in the oil tank has dropped, indicating that the oil pump is functioning properly. If the level has not dropped, see your dealer for oil pump bleeding and repeat the pre-mix procedure.

Fuel/Oil Premix Chart

Fuel	Oil @ 40:1
Gallons (Liters)	Ounces (Liters)
1 (3.8)	3.2 (.09)
5 (18.9)	16 (.47)
10 (37.9)	32 (.95)

OPERATION

Pre-Ride Inspection

WARNING

If a proper inspection is not done before each use, severe injury or death could result. Always inspect the vehicle before each use to ensure it's in proper operating condition.

Pre-Ride Checklist		
Item	Remarks	See Page
Brake system / lever travel	Ensure proper operation	36, 75
Brake fluid	Ensure proper level	35
Auxiliary brake	Ensure proper operation	38
Front suspension	Inspect, lubricate if necessary	69
Rear suspension	Inspect, lubricate if necessary	69
Steering	Ensure free operation	-
Tires	Inspect condition and pressure	82
Wheels / fasteners	Inspect, ensure fastener tightness	81
Frame nuts, bolts, fasteners	Inspect, ensure tightness	-
Fuel and oil	Ensure proper levels	71
Coolant level (if applicable)	Ensure proper level	-
Coolant hoses (if applicable)	Inspect for leaks	-
Throttle	Ensure proper operation	33, 78
Indicator lights / switches	Ensure operation	34
Engine stop switch	Ensure proper operation	32
Drive chain	Check condition / slack, lubricate as needed	85
Air filter, pre-filter	Inspect, clean	86
Air box sediment tube	Drain deposits whenever visible	-
Headlamp	Check operation	87
Brake light / tail lamp	Check operation, apply Polaris dielectric grease when lamp is replaced	89
Riding gear	Wear helmet, goggles, protective clothing	31

Starting the Engine

Starting a Cold Engine

⚠ WARNING

Engine exhaust contains poisonous carbon monoxide and can cause loss of consciousness resulting in severe injury or death. Never run an engine in an enclosed area.

CAUTION

Operating the vehicle immediately after starting could cause engine damage. Allow the engine to warm up for several minutes before operating the vehicle.

1. Place the transmission in neutral and lock the parking brake. Make sure the fuel valve is on.
2. Sit on the vehicle and pull the choke knob (1) out until it stops.

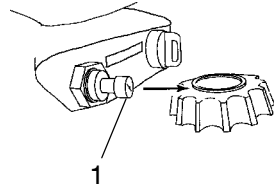

NOTE: If the knob doesn't stay where positioned, increase the tension by rotating the tension adjusting nut (2) clockwise.

NOTE: The variable choke is fully on when the knob is pulled completely out. The choke is off when the knob is pushed completely in. The choke can be adjusted gradually, depending on how much choke is needed for starting. Be sure the choke is off during operation, as excess fuel washing into the engine oil will increase wear on engine components.

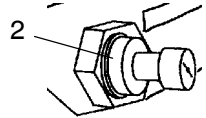

3. Move the engine stop switch to RUN.

NOTE: Do not press the throttle while starting the engine.

4. Turn the ignition key past the ON position to engage the starter for a maximum of five seconds. Release the key when the engine starts. If it doesn't start, release the key and wait five seconds. Activate the starter for another five seconds. Repeat until the engine starts.
5. If the engine slows or stops, position the choke knob half way in to allow proper engine warm up.
6. Vary the engine RPM slightly with the throttle to aid in warm-up. When the engine idles smoothly, push the choke all the way in.

OPERATION

Starting the Engine

Starting a Warm Engine

Warm engines do not normally require the use of the choke. Excessive use of the choke can cause the spark plug to become wet fouled.

1. Position the vehicle on a level surface and place the transmission in neutral.
2. Lock the parking brake, turn the fuel tank valve to ON, sit on the vehicle, and turn the engine stop switch to RUN.
3. If the engine has cooled to a point where it does not readily start, intermittent use of the choke (pulled half way out) may be necessary.

NOTE: If the engine is over-choked when warm, depress the throttle lever fully while cranking to aid in starting.

4. Release the throttle lever immediately after the engine starts. If the engine does not start and all conditions are favorable, change the spark plug and try again.

Driving Safely Driving Procedures



1. Sit upright with both feet on the footrests and both hands on the handlebars.
2. Start the engine and allow it to warm up, then shift the transmission into gear.
3. Check your surroundings and determine your path of travel.
4. Release the parking brake.
5. Slowly depress the throttle with your right thumb and begin driving. Vehicle speed is controlled by the amount of throttle opening.
6. Drive slowly. Practice maneuvering and using the throttle and brakes on level surfaces.

OPERATION

Driving Safely

Making Turns

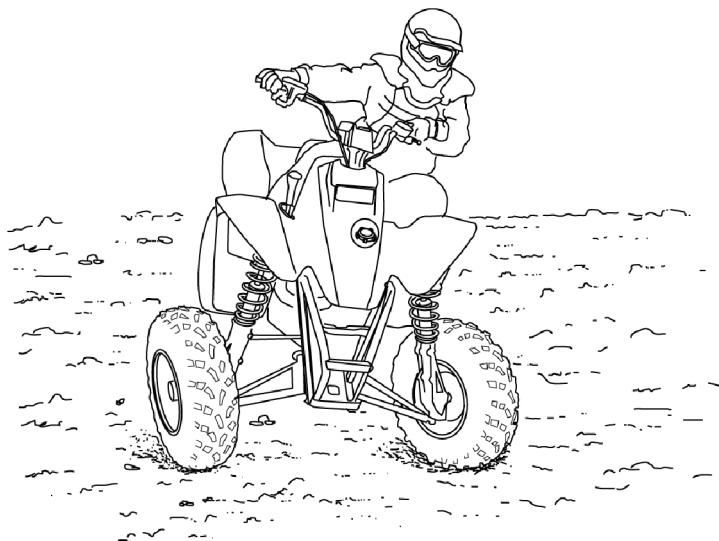

Your Polaris ATV is equipped with a solid rear axle that drives both rear wheels equally at all times. This means that the wheel on the outside of the turn must travel a greater distance than the inside wheel when turning and the inside tire must slip traction slightly.

To make a turn, steer in the direction of the turn, leaning your upper body to the inside of the turn while supporting your weight on the outer footrest. This technique alters the balance of traction between the rear wheels, allowing the turn to be made smoothly. The same leaning technique should be used for turning in reverse.

NOTE: Practice making turns at slow speeds before attempting to turn at faster speeds.

WARNING

Turning at sharp angles or at excessive speeds can result in vehicle overturn and lead to serious injury. Avoid turning at sharp angles. Never turn at high speeds.

Driving Safely

Driving on Slippery Surfaces



Whenever riding on slippery surfaces such as wet trails or loose gravel, or during freezing weather, follow these precautions:

1. Slow down when entering slippery areas.
2. Maintain a high level of alertness, reading the trail and avoiding quick, sharp turns which can cause skids.
3. Correct a skid by turning the handlebars in the direction of the skid and shifting your body weight forward.

⚠ WARNING

Failure to exercise care when operating on slippery surfaces can result in loss of tire traction and cause loss of control, accident, and serious injury or death.

Never apply the brakes during a skid.

Do not operate on excessively slippery surfaces.

Always reduce speed and use additional caution.

OPERATION

Driving Safely

Driving Uphill

Whenever traveling uphill, follow these precautions:

1. Always travel straight uphill.
2. Avoid steep hills (25° maximum).
3. Keep both feet on the footrests.
4. Transfer your weight forward.
5. Proceed at a steady rate of speed and throttle opening.
6. Remain alert and be prepared to take emergency action. This may include quick dismounting of the vehicle.

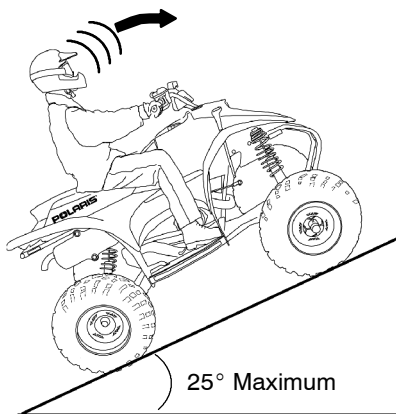

If all forward speed is lost:

Keep your weight uphill.

Apply the single lever brake, gradually. When fully stopped, apply the auxiliary brake as well, then lock the park brake.

If the ATV begins rolling backwards:

Keep your weight uphill. Never apply engine power. Never apply the auxiliary rear brake while rolling backwards.

Apply the single-lever brake, gradually. When fully stopped, apply the auxiliary rear brake as well, and then lock the parking brake.

Dismount on uphill side, or to either side if ATV is pointed straight uphill. Turn the ATV around and remount, following the procedure described on page 55.

WARNING

Braking and handling are greatly affected when operating in hilly terrain. Improper procedure could cause loss of control or overturn and result in serious injury or death.

Avoid climbing steep hills (25° maximum).

Use extreme caution when operating on hills, and follow proper operating procedures outlined in the owner's manual.

Driving Safely Sidehilling



⚠ WARNING

Improperly crossing hills or turning on hills can result in loss of control or vehicle overturn, resulting in severe injury or death. Avoid crossing the side of a hill when possible. Follow proper procedures as outlined in the owner's manual.

Sidehilling can be a dangerous type of driving and should be avoided if at all possible. If you do enter into a situation where sidehilling is necessary, follow these precautions:

1. Slow down.
2. Lean into the hill, transferring your upper body weight toward the hill while keeping your feet on the footrests.
3. Steer slightly into the hill to maintain vehicle directions.

NOTE: If the vehicle begins to tip, quickly turn the front wheel downhill, if possible, or dismount on the uphill side *immediately!*

OPERATION

Driving Safely

Driving Downhill



Whenever descending a hill, follow these precautions:

1. Proceed directly downhill.
2. Transfer your weight to the rear of the vehicle.
3. Slow down.
4. Apply the brakes *slightly* to aid in slowing, using the single brake lever.

NOTE: Familiarize yourself with operation of the auxiliary rear brake pedal for additional braking in the event of normal service brake loss.

WARNING

Excessive speed can cause loss of control and lead to serious injury or death. Always operate slowly when traveling downhill.

Driving Safely

Turning Around on a Hill

⚠ WARNING

Improper hill climbing procedures could cause loss of control or overturn and result in serious injury or death.

Avoid climbing steep hills (25° maximum).

Use extreme caution when operating on hills, and follow proper operating procedures outlined in the owner's manual.

If the vehicle stalls while climbing a hill, never back it down the hill! One maneuver that can be used when it's necessary to turn around while climbing a hill is the K-turn:

1. Stop and lock the parking brake while keeping body weight uphill.
2. Leave transmission in forward and shut off the engine.
3. Dismount on the uphill side of the vehicle, or on the left if the vehicle is pointing straight uphill.
4. Staying uphill of the vehicle, turn the handlebars full left.
5. While holding the brake lever, release the parking brake lock and slowly allow the vehicle to roll around to your right until it's pointing across the hill or slightly downward.
6. Lock the parking brake and remount the vehicle from the uphill side, keeping body weight uphill.
7. Restart the engine with the transmission still in forward.
8. Release the parking brake and proceed *slowly*, controlling speed with the brake, until the vehicle is on more level ground.

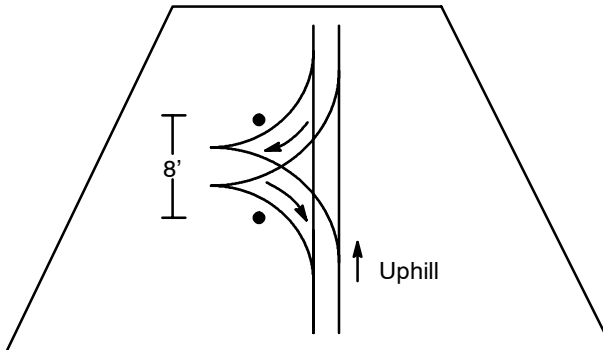

OPERATION

Driving Safely

Driving Through Water

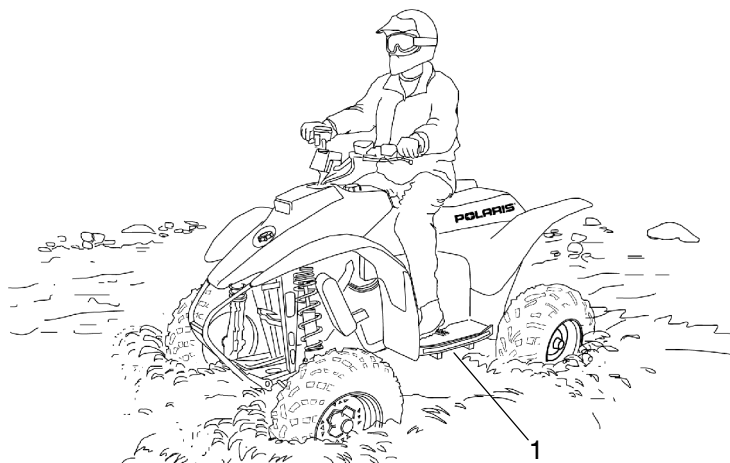

Your ATV can operate through water with a maximum recommended depth equal to the bottom of the footrests (1). Follow these procedures when operating through water:

1. Determine water depths and current before crossing.
2. Choose a crossing where both banks have gradual inclines.
3. Proceed slowly, avoiding rocks and obstacles if possible.
4. After crossing, dry the brakes by applying light pressure to the lever until braking action is normal.

After running the vehicle in water, it's *critical* to have it serviced as outlined in the maintenance chart. See page 64. The following areas need special attention: engine oil, transmission oil, front and rear gearcases and all grease fittings.

Driving Safely

Driving Through Water

CAUTION

Major engine damage can result if the vehicle is not thoroughly inspected after operation in water. Perform the services outlined in the maintenance chart.

If your vehicle becomes immersed or is operated in water that exceeds the footrest level, take it to your dealer for service before starting the engine.

NOTE: Avoid operating the vehicle through deep or fast-flowing water. If you cannot avoid water that exceeds the recommended maximum depth, go slowly, balance your weight carefully, avoid sudden movements, and maintain a slow and steady forward motion. Do not make sudden turns or stops, and do not make sudden throttle changes.

If your vehicle becomes immersed, and it's impossible to take it to a dealer before starting it, follow the steps described on page 91. Have the vehicle serviced by your dealer at the first opportunity.

OPERATION

Driving Safely

Driving Over Obstacles



Be alert! Look ahead and learn to read the terrain you're traveling on. Be constantly alert for hazards such as logs, rocks and low hanging branches.

WARNING

Severe injury or death can result if your vehicle comes in contact with a hidden obstacle. Not all obstacles are immediately visible. Travel with caution in unfamiliar terrain.

Driving Safely

Driving in Reverse

Follow these precautions when operating in reverse:

1. Always avoid backing downhill.
2. Back slowly.
3. When in reverse, apply the brakes *lightly* for stopping.
4. Avoid turning at sharp angles in reverse.
5. Never open the throttle suddenly while backing.



⚠ WARNING

Failure to use caution when operating in reverse can result in serious injury or death. Before shifting into reverse, always check for obstacles or people behind the vehicle. When it's safe to proceed, back slowly.

Do not use the override switch unless additional power is required for vehicle movement. Use with caution.

Avoid backing on inclines, and avoid turning at sharp angles.

NOTE: Most Polaris ATVs are equipped with a reverse speed limiter. The override button should be used with caution as rearward vehicle speed is greatly increased. Do not operate at wide open throttle. Open the throttle just enough to maintain a desired speed.

CAUTION

Excessive throttle operation while in the speed limit mode may cause fuel to build in the exhaust, resulting in engine popping and/or engine damage.

OPERATION

Hauling Cargo



Your ATV has been designed to carry or tow a certain amount of load (if equipped with racks). Always read and understand the load distribution warning labels on the vehicle, and never exceed the weight capacities outlined in the specifications section of the owner's manual and on the safety decals.

Cargo weight should be evenly distributed ($\frac{1}{3}$ on the front rack and $\frac{2}{3}$ on the rear rack) and mounted as low as possible. When operating over rough or hilly terrain, reduce speed and cargo weight to maintain stable driving conditions. Do not obstruct the headlight beam with cargo.

Hauling Cargo

WARNING

Hauling cargo improperly can alter vehicle handling and may cause loss of control or brake instability and result in serious injury or death. Always follow these precautions when hauling cargo:

- **REDUCE SPEED AND ALLOW GREATER DISTANCE FOR BRAKING WHEN HAULING CARGO.**
- **CARGO WEIGHT DISTRIBUTION** should be 1/3 on the front rack and 2/3 on the rear rack. When operating over rough or hilly terrain, reduce speed and cargo to maintain stable driving conditions. Carrying loads on one rack only increases the possibility of vehicle overturn.
- **LOADS MUST BE CARRIED AS LOW ON THE RACKS AS POSSIBLE.** Carrying loads high on the racks raises the center of gravity of the vehicle and creates a less stable operating condition. When cargo loads are carried high on the racks, the weight of the loads must be reduced to maintain stable operating conditions.
- **ALL LOADS MUST BE SECURED BEFORE OPERATING.** Unsecured loads can create unstable operating conditions, which could result in loss of control of the vehicle.
- **OPERATE ONLY WITH STABLE AND SAFELY ARRANGED LOADS.** When handling off-centered loads that cannot be centered, securely fasten load and operate with extra caution. Always attach the tow load to the hitch point designated for your vehicle.
- **HEAVY LOADS CAN CAUSE BRAKING AND CONTROL PROBLEMS.** Use extreme caution when applying brakes with a loaded vehicle. Avoid terrain or situations that may require backing downhill.
- **EXTREME CAUTION MUST BE USED** when operating with loads extending over the rack sides. Stability and maneuverability may be adversely affected, causing the machine to overturn.
- **DO NOT BLOCK THE FRONT HEADLIGHT BEAM** when carrying loads on the front rack.
- **DO NOT TRAVEL FASTER THAN THE RECOMMENDED SPEEDS.** Vehicle should never exceed 10 mph (16 kph) while towing a load on a level grass surface. Vehicle speed should never exceed 5 mph (8 kph) when towing loads in rough terrain, while cornering, or while ascending or descending a hill.

OPERATION

Driving Safely

Parking on an Incline

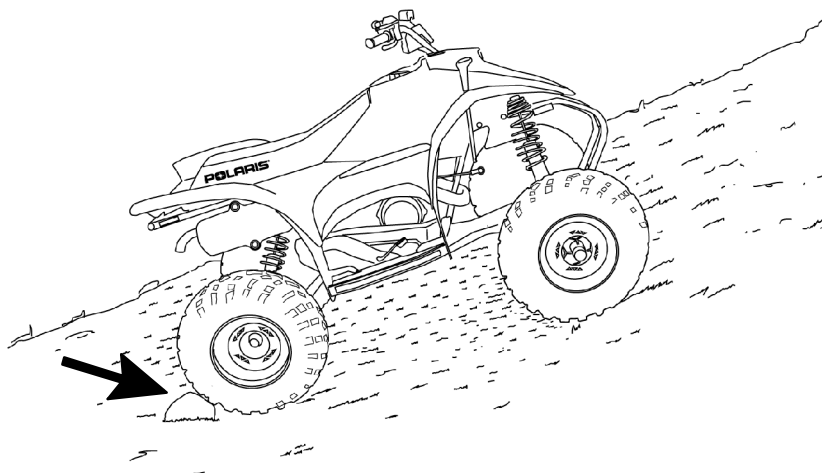

Avoid parking on an incline if possible. If it's unavoidable, follow these precautions:

1. Turn the engine off.
2. Place the transmission in gear.
3. Set the parking brake.
4. Always block the rear wheels on the downhill side. See illustration.
5. Shut off the fuel supply.

EMISSION CONTROL SYSTEMS

Noise Emission Control System

Do not modify the engine, intake or exhaust components, as doing so may affect compliance with state and local noise level requirements.

Spark Arrestor

Your Polaris vehicle has a spark arrestor that was tested and approved in accordance with the USDA Forest Service Standard 5100-1C.

Federal law requires that this spark arrestor be installed and functional when the vehicle is operated on public lands.

Electromagnetic Interference

This spark ignition system complies with Canadian ICES-002.

MAINTENANCE AND LUBRICATION

Accessories

Auxiliary power outlets provide 12V power for operating accessories such as hand held spot lights. See your Polaris dealer.

Periodic Maintenance Chart

Careful periodic maintenance will help keep your vehicle in the safest, most reliable condition. Inspection, adjustment and lubrication of important components are explained in the periodic maintenance chart.

Inspect, clean, lubricate, adjust and replace parts as necessary. When inspection reveals the need for replacement parts, use genuine Polaris parts available from your Polaris dealer.

NOTE: Service and adjustments are critical. If you're not familiar with safe service and adjustment procedures, have a qualified dealer perform these operations.

Maintenance intervals in the following chart are based upon average riding conditions and an average vehicle speed of approximately 10 miles per hour. Vehicles subjected to severe use must be inspected and serviced more frequently.

Severe Use Definition

- Frequent immersion in mud, water or sand
- Racing or race-style high RPM use
- Prolonged low speed, heavy load operation
- Extended idle
- Short trip cold weather operation

Pay special attention to the oil level. A rise in oil level during cold weather can indicate contaminants collecting in the oil sump or crankcase. Change oil immediately if the oil level begins to rise. Monitor the oil level, and if it continues to rise, discontinue use and determine the cause or see your dealer.

Maintenance Chart Key

- ▶ Perform these procedures more frequently for vehicles subjected to severe use.
- E Emission Control System Service (California)
- Have an authorized Polaris dealer perform these services.

WARNING

Improperly performing the procedures marked with a ■ could result in component failure and lead to serious injury or death. Have an authorized Polaris dealer perform these services.

MAINTENANCE AND LUBRICATION

Periodic Maintenance Chart

Perform all services at whichever maintenance interval is reached first.

Item		Maintenance Interval (whichever comes first)			Remarks
		Hours	Calendar	Miles (Km)	
■	Steering	-	Pre-Ride	-	Make adjustments as needed. See Pre-Ride Checklist on page 46.
▶	Front suspension	-	Pre-Ride	-	
▶	Rear suspension	-	Pre-Ride	-	
	Tires	-	Pre-Ride	-	
▶	Brake fluid level	-	Pre-Ride	-	
▶	Brake lever travel	-	Pre-Ride	-	
	Brake system	-	Pre-Ride	-	
	Wheels/fasteners	-	Pre-Ride	-	
	Frame fasteners	-	Pre-Ride	-	
▶ E	Engine oil level	-	Pre-Ride	-	
▶ E	Air filter, pre-filter	-	Daily	-	Inspect; clean often
▶ E	Air box sediment tube	-	Daily	-	Drain deposits when visible
	Headlamp	-	Daily	-	Check operation
	Tail light	-	Daily	-	Check operation; apply dielectric grease if replacing
▶ E	Air filter, main element	-	Weekly	-	Inspect; replace as needed
	Recoil housing	-	Weekly	-	Drain water as needed, check often if operating in wet conditions
▶ ■	Brake pad wear	10 H	Monthly	100 (160)	Inspect periodically
	Battery	20 H	Monthly	200 (320)	Check terminals; clean; test
▶	Transmission oil	25 H	Monthly	250 (400)	Inspect level; change yearly
▶ E	Engine breather filter (if equipped)	25 H	Monthly	250 (400)	Inspect; clean if needed
▶	General lubrication	50 H	3 M	500 (800)	Lubricate all fittings, pivots, cables, etc.

MAINTENANCE AND LUBRICATION

Periodic Maintenance Chart

Item		Maintenance Interval (whichever comes first)			Remarks
		Hours	Calendar	Miles (Km)	
	Carburetor float bowl	50 H	6 M	500 (800)	Drain bowl periodically and prior to storage
■ E	Throttle Cable/ ETC Switch	50 H	6 M	500 (800)	Inspect; adjust; lubricate; replace if necessary
■ E	Choke cable	50 H	6 M	500 (800)	Inspect; adjust; lubricate; replace if necessary
E	Carburetor air intake ducts/ flange	50 H	6 M	500 (800)	Inspect ducts for proper sealing/air leaks
	Drive belt	50 H	6 M	500 (800)	Inspect; adjust; replace as needed
▶ E	Engine oil change	100 H	6 M	1000 (1600)	Perform a break-in oil change at one month
▶ E	Oil filter change	100 H	6 M	1000 (1600)	Replace with oil change
■ E	Valve clearance	100 H	12 M	1000 (1600)	Inspect; adjust
■ E	Fuel system	100 H	12 M	1000 (1600)	Check for leaks at tank cap, lines, fuel valve, filter, pump, carburetor; replace lines every two years
■ E	Fuel filter	100 H	12 M	1000 (1600)	Replace yearly
▶	Engine mounts	100 H	12 M	1000 (1600)	Inspect
	Exhaust muffler/ pipe	100 H	12 M	1000 (1600)	Inspect
■ E	Spark plug	100 H	12 M	1000 (1600)	Inspect; replace as needed
■ E	Ignition Timing	100 H	12 M	1000 (1600)	Inspect
▶	Wiring	100 H	12 M	1000 (1600)	Inspect for wear, routing, security; apply dielectric grease to connectors subjected to water, mud, etc.
■	Clutches (drive and driven)	100 H	12 M	1000 (1600)	Inspect; clean; replace worn parts
■	Front wheel bearings	100 H	12 M	1000 (1600)	Inspect; replace as needed

MAINTENANCE AND LUBRICATION

Periodic Maintenance Chart

Item		Maintenance Interval (whichever comes first)			Remarks
		Hours	Calendar	Miles (Km)	
■	Brake fluid	200 H	24 M	2000 (3200)	Change every two years
	Spark arrestor	300 H	36 M	3000 (4800)	Clean out
E	Idle speed	-			Adjust as needed
■	Toe adjustment	-			Inspect periodically; adjust when parts are replaced
	Headlight aim	-			Adjust as needed

- ▶ Perform these procedures more often for vehicles subjected to severe use.
- E Emission Control System Service (California)
- Have an authorized Polaris dealer perform these services.

MAINTENANCE AND LUBRICATION

Lubrication Recommendations

Check and lubricate all components at the intervals outlined in the Periodic Maintenance Chart beginning on page 65.

Lubrication Chart Key

- ▶ More often under severe use, such as wet or dusty conditions
- ★ Polaris Premium All Season Grease or grease conforming to NLG No. 2, such as Conoco Superlube M or Mobilegrease Special

Item	Lube	Method
Engine	Polaris Injection Oil	Fill oil tank. See page 41.
Brakes	DOT 3 fluid only	Maintain level between fill lines. See page 35.
Drive chain(s)	O-ring chain lube or SAE 80/90	Lubricate as often as required. Before each ride in wet conditions
Transmission	AGL Synthetic Gear-case Lube	See Page 72.
(1) Ball Joint	▶★ Grease	Locate fitting on back side of struts and grease with grease gun.
(2) Swing Arm Bushings	▶★ Grease	Locate fittings on swing arm and grease with grease gun.
(3) Axle Housing	▶★ Grease	Locate fittings on swing arm and grease with grease gun.

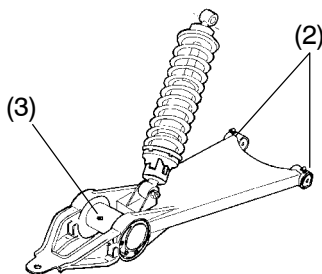
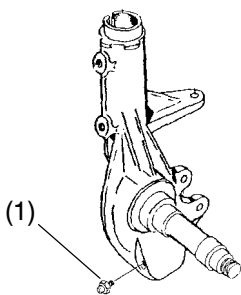

MAINTENANCE AND LUBRICATION

Lubrication Recommendations

Polaris 2-Cycle Lubricants

Polaris Premium 2-cycle lubricants are the most advanced formulation of oils, specifically designed for today's 2-cycle engines. These lubricants provide additives for 2-cycle engines that are lacking in today's fuel. These necessary additives keep ring grooves cleaner for less ring sticking and improved overall engine cleanliness.

With new generation lubricity technology, Polaris oils excel in meeting the lubrication demands of today's high performance 2-cycle engines. We recommend the use of these optimum oils for Polaris liquid cooled or air cooled 2-cycle engines.

Polaris premium 2-cycle oils will mix with each other, but consistent performance will be enhanced by selecting only one of the premium oils and maintaining regular use of that oil through the life of the unit. Your dealer will be able to assist you with that selection, based on your operating conditions and riding style.

Never mix Polaris premium 2-cycle oils with any other brand of oil, including Polaris Nature Oil Biodegradable oil. Their incompatibility could result in engine damage. For best performance, we recommend that you choose one oil for your ATV, then continue to use it for the life of the unit.

See page 106 for the part numbers of Polaris products.

Polaris VES II Synthetic 2-Cycle Oil

Your vehicle has been primed with VES II synthetic oil. We recommend the continued use of this oil for your ATV. This lubricant has been specially formulated for low smoke, low odor, low deposits and high lubricity.

Premium 2-Cycle Oil

Polaris also has a TC-W3 premium oil or Premium Gold Synthetic Oil suitable for use in all of our 2-cycle products.

CAUTION

Mixing brands or using a non-recommended oil may cause serious engine damage. We recommend the use of Polaris 2-cycle oils for your 2-cycle engine. Never mix oil brands.

MAINTENANCE AND LUBRICATION

Lubrication Recommendations

Engine Oil Check

The oil tank cap (1) is located forward of the headlight. Check the oil before each use of the vehicle. Refill the oil when refueling.

1. Position the ATV on a level surface.
2. Remove the oil tank cap and inspect the oil level in the tank.
3. Add oil as needed to bring the level to the full mark. Do not overfill.
4. Reinstall the oil tank cap.

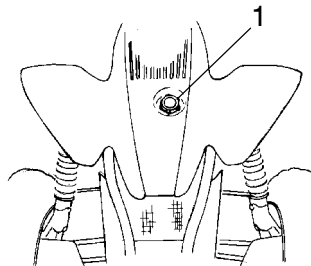

MAINTENANCE AND LUBRICATION

Lubrication Recommendations

Transmission Oil Check

The transmission oil dipstick (1) is located on the right side of the vehicle. Check and change the transmission oil at the intervals outlined in the Periodic Maintenance Chart beginning on page 65. Maintain the transmission oil level in the SAFE operating range (2). We recommend the use of AGL Synthetic Gearcase Lubricant. See page 106 for the part numbers of Polaris products.

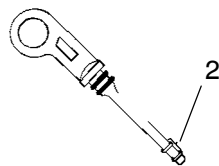
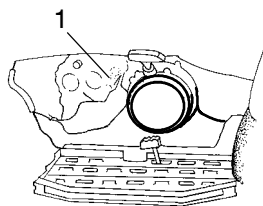

1. Position the ATV on a level surface.
2. Remove the transmission oil dipstick and wipe it clean.
3. Reinstall the dipstick, then remove it and read the oil level. If the level is low, add the recommended gearcase oil to bring the level within the safe operating range on the dipstick.
4. Reinstall the dipstick.

Transmission Oil Change

1. Place a drain pan beneath the transmission oil drain plug area.
2. Loosen the jam nut (A).
3. Turn the adjuster bolt (B) in to allow the removal of the drain plug (C).
4. Remove the drain plug and wipe the magnetic end clean to remove accumulated metallic filings.
5. After the oil has drained completely, install a new sealing washer and reinstall the drain plug. Torque to 14 ft. lbs. (19 Nm).
6. Turn the adjuster bolt (B) out until it touches the frame, and then turn an additional 1/2 turn.
7. Tighten the jam nut securely while holding the adjuster bolt.
8. Add the recommended lubricant through the dipstick hole until the oil level is between the upper and lower limits. Do not overfill.
9. Check for leaks.

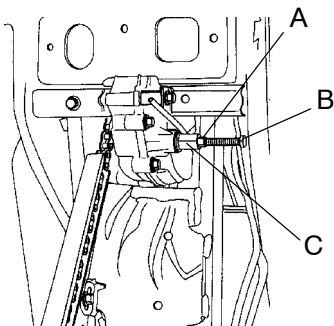

MAINTENANCE AND LUBRICATION

Adjustments

Oil Pump Bleeding

CAUTION

If the oil supply line has been disconnected from the pump, or if the oil reservoir and supply line have been completely run out of oil, the oil pump must be bled. If the pump is not bled, air in the lines may prevent oil delivery to the engine, resulting in severe engine damage.

1. Fill the oil tank with the recommended oil. See page 106 for the part numbers of Polaris products.
2. Loosen the bleeder screw one full turn. Allow oil to flow from the bleed screw for five to ten seconds, then tighten the bleed screw.

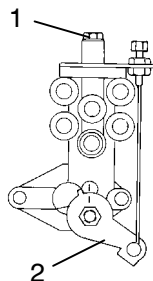

CAUTION

Allowing the engine to run while the bleed screw is loose will result in loss of oil, which will cause serious engine damage. Always retighten the bleed screw if it's been loosened for service.

3. Start the engine and rotate the oil pump lever (2) to its full open position. With the engine at idle, hold the lever up for thirty seconds to purge all air from the system.

MAINTENANCE AND LUBRICATION

Adjustments

Oil Pump

If it becomes necessary to increase oil flow into the fuel system, the oil pump can be adjusted.

1. Before adjusting the oil pump, check the engine idle RPM and carburetor settings in the specifications section beginning on page 103.
2. Loosen the throttle cable jam nut and turn the adjuster (1) in or out until there is 1/16" - 1/8" (.16 - .32 cm) of throttle lever travel before the throttle slide starts to open.
3. Place very slight pressure on the throttle lever (2) until all freeplay is removed from the throttle cable (to the point where the carb slide is just starting to rise).
4. Loosen the locknut (3). Turn the adjuster in or out until all freeplay is removed from the oil pump cable (the point where the oil pump arm is just starting to move off its stop). The pump stop keeps the pump arm from rotating any further down than the idle position so no visual alignment of marks is necessary. Tighten the locknut.

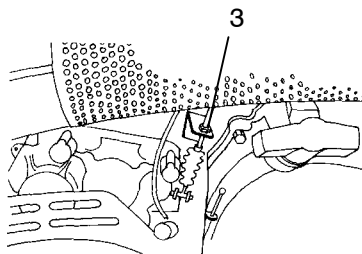
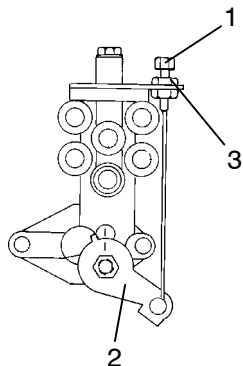

MAINTENANCE AND LUBRICATION

Adjustments

Brakes

The front and rear brakes are hydraulic disc brakes, activated by moving the single brake lever toward the handlebar. These brakes are self-adjusting.

The following checks are recommended to keep the brake system in good operating condition. Check more often if brakes are used heavily under normal operation, such as operation in hilly country or in muddy terrain.

1. Always maintain brake fluid level as recommended (see page 35).
2. Check the brake system for fluid leaks.
3. Check the brakes for excessive travel or spongy feel.
4. Check the friction pads for wear, damage and looseness.
5. Check the security and surface condition of the disc.

NOTE: Install new brake pads when pads are worn to $3/64''$ (.1 cm).

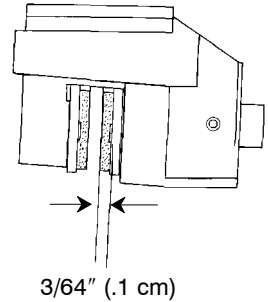

Auxiliary Brake

The auxiliary brake system is intended to be used as a backup for the main brake system. Should the main system fail, the rear brake can be activated by depressing the foot pedal on the inside of the right footrest.

NOTE: Since this is a rear brake only, it will not be as effective as the all-wheel single lever system.

The hydraulic auxiliary brake system requires no adjustment.

Always maintain the brake fluid level as recommended. See page 38.

MAINTENANCE AND LUBRICATION

Adjustments

WARNING

Severe injury or death can result from improper toe alignment and adjustment. Do not attempt to adjust tie rod alignment. All tie rod adjustments should be performed by an authorized Polaris dealer.

Toe Alignment

Use the following procedure to check the toe alignment of the vehicle. The recommended toe alignment is $1/8''$ to $1/4''$ toe out.

1. Set the handlebars in a straight-ahead position.

NOTE: The steering frog can be used as an indicator of whether the handlebars are straight. The frog should always point straight back from the steering post.

2. Place stands (1) in front of the vehicle, perpendicular to the rear tires. See illustration.
3. Tie an elastic string around the stands, making sure the string just touches the side surface of the rear tires on each side of the vehicle and goes around the stands in front of the vehicle (2).
4. Measure the distance from the string to the rim at the front and rear of the front rim (3). Rear measurement should be $1/16''$ - $1/8''$ (.2 to .3 cm) more than the front measurement.

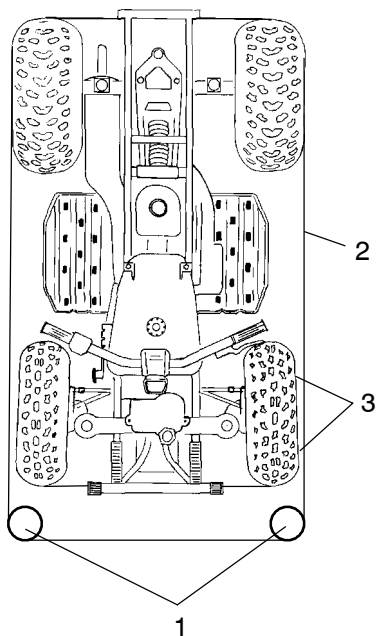

NOTE: If you discover improper alignment, see your Polaris dealer for service.

MAINTENANCE AND LUBRICATION

Adjustments

Steering Assembly

The steering assembly of the ATV should be checked periodically for loose nuts and bolts. If loose nuts and bolts are found, see your Polaris dealer for service before operating the vehicle.

Camber and Caster

The camber and caster are non-adjustable.

Rear Spring

The rear shock absorber spring is adjusted by rotating the adjuster (1) either clockwise or counterclockwise to increase or decrease spring tension.

NOTE: Accessory springs are available through your Polaris dealer.

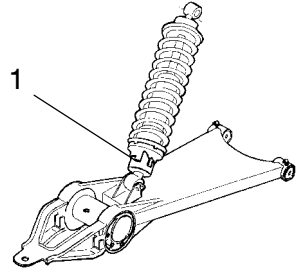

MAINTENANCE AND LUBRICATION

Adjustments

WARNING

Improper adjustment of the handlebars or incorrect torquing of the adjuster block tightening bolts can cause limited steering or loosening of the handlebars, resulting in loss of control and possible serious personal injury or death. Follow the adjustment procedures exactly, or see your Polaris dealer for service.

Handlebars

The handlebars can be adjusted for rider preference.

1. Remove the handlebar cover and locate handlebar bolts (1).
2. Loosen the four bolts.
3. Adjust the handlebar to the desired height. Be sure the handlebars do not contact the gas tank or any other part of the machine when turned fully to the left or right.
4. Torque the front two bolts to 10-12 ft. lbs. (14-17 Nm), then torque the rear two bolts. A gap of up to 1/8" will remain at the rear bolts.

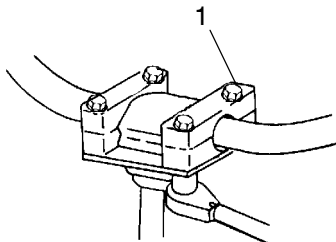

Throttle Cable Freeplay

Throttle cable freeplay is adjusted at the handlebar.

1. Slide the boots (1) off the inline cable adjuster sleeve (2). Loosen the adjuster locknut (3).
2. Turn the adjuster until 1/16" to 1/8" freeplay is achieved at the thumb lever.

NOTE: While adjusting freeplay, be sure to flip the throttle lever back and forth.

3. Tighten the locknut and slide the boots over the cable adjuster until they touch at the midpoint of the adjuster.

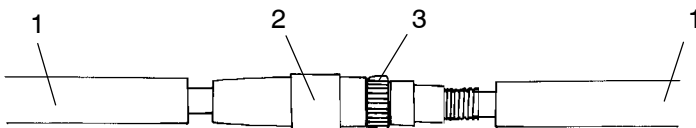

MAINTENANCE AND LUBRICATION

Adjustments

Carburetor

IMPORTANT: Your Polaris ATV is calibrated at the factory for optimal performance at altitudes ranging from zero to 6,000 feet (1800 m) and temperatures of +40 degrees F. (4 degrees C.) or higher. Above 6000 feet (1800 m) the engine air/fuel mixture becomes overly rich and the engine loses approximately 3% of its power for each 1000-foot (304.8 m) increase in elevation. Although this power cannot be regained, adjustments to the carburetor and drive system can be made to allow more efficient operation. Optional jets, available from your Polaris dealer, are required for operation above 6,000 feet and temperatures below +40 degrees F. (4 degrees C.)

NOTE: Continuous operation of the engine without proper jetting when required can cause poor performance, overheating or engine damage. See your Polaris dealer for more information about jetting the ATV for conditions in your area.

If the engine idle speed is not satisfactory, and all other conditions are favorable, the carburetor can be adjusted.

1. Warm up the engine by running the vehicle for approximately five minutes.
2. Place the transmission in gear and lock the parking brake.
3. Adjust the carburetor idle screw (1) either in or out until the desired idle RPM is reached. Turn the screw in (clockwise) to raise RPM. Turn the screw out (counterclockwise) to lower RPM.

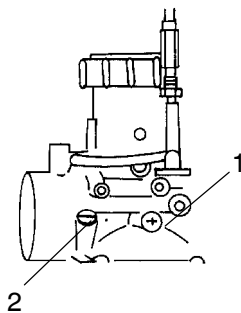

The following variations apply to air screw (2) adjustment for 2-cycle engines:

- For improving cold weather start and reducing audible detonation noise, the air screw can be closed from 1/2 to 1 turn by turning the screw clockwise.
- During hot weather and/or high altitude operation the air screw can be adjusted for smoother operation by turning the screw counterclockwise for approximately 2 turns.

MAINTENANCE AND LUBRICATION

Adjustments

WARNING

Operating your ATV with worn tires, improperly inflated tires, non-standard tires or improperly installed tires will affect vehicle handling and could cause an accident resulting in serious injury or death.

Maintain proper tire pressure as described on the decal on your ATV and in your owner's manual.

Always use original equipment size and type when replacing tires.

Make sure the wheels are installed properly.

Always replace tires when the tread depth measures 1/8" (.3 cm) or less.

Wheel Removal

1. Stop the engine, place the transmission in gear and lock the parking brake.
2. Loosen the wheel nuts slightly.
3. Elevate the side of the vehicle by placing a suitable stand under the footrest frame.
4. Remove the wheel nuts and remove the wheel.

MAINTENANCE AND LUBRICATION

Adjustments

Wheel Installation

1. Place the transmission in gear and lock the parking brake.

⚠ WARNING

Improperly installed wheels can adversely affect tire wear and vehicle handling, which can result in serious injury or death. Always ensure that all nuts are torqued to specification. Do not service axle nuts that have a cotter pin installed. See your Polaris dealer.

2. Place the wheel on the wheel hub with the valve stem toward the outside and the rotation arrows on the tire pointing toward forward rotation.
3. Install the wheel nuts and finger tighten. On vehicles with tapered rear wheel nuts, make sure the tapered ends of the nuts fit into the tapers on the wheels.
4. Lower the vehicle to the ground.
5. Torque the wheel nuts according to the wheel nut torque specifications chart.

Wheel Nut Torque Specifications

Check the wheel nut torques occasionally and when they've been loosened for maintenance service.

Item	Specification
Front Wheel Nuts	27 ft. lbs. (36.5 Nm)
Rear Wheel Nuts	50 ft. lbs. (68 Nm)

Front

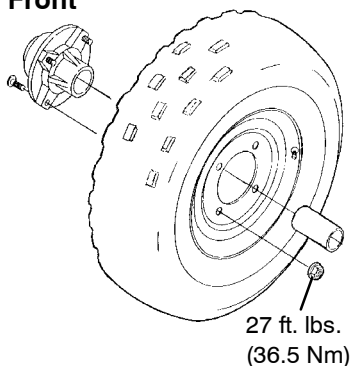

Rear

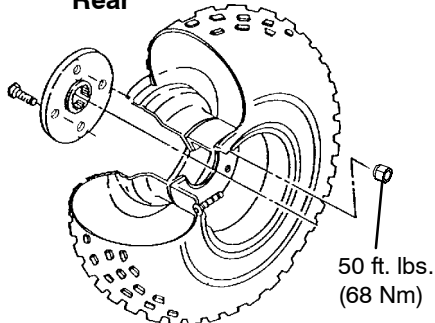

MAINTENANCE AND LUBRICATION

Adjustments

Front Wheel Hub Tightening

Front wheel bearing tightness and spindle nut retention are critical component operations. All service must be performed by your authorized Polaris dealer.

Tire Tread Depth

Always replace tires when tread depth is worn to $1/8''$ (.3 cm) or less. See illustration.

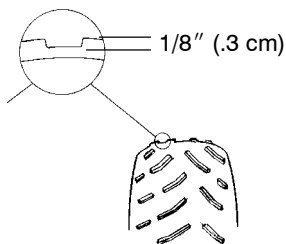

⚠ WARNING

Operating the vehicle with worn tires will increase the possibility of skidding, which could lead to loss of control and serious injury or death. Always replace tires when the tread depth measures $1/8''$ (.3 cm) or less.

⚠ WARNING

Use of non-standard size or type of tires or improper tire inflation may adversely affect vehicle maneuverability and cause loss of control resulting in serious injury or death. Maintain proper tire pressure as outlined in this owner's manual. When replacing a tire always use original equipment size and type.

MAINTENANCE AND LUBRICATION

Adjustments

Drive Chain

Polaris ATV drive chains are equipped with o-ring-sealed, permanently greased pins and rollers. However, the outer surfaces of the roller must be lubricated.

1. Always inspect the drive chain prior to operating the vehicle. Check for damaged or missing o-rings or damaged rollers.
2. Check for correct slack adjustment.
3. Maintain the stone guard to rear sprocket clearance at 1/8" (.3 cm).
4. Regularly lubricate the drive chain with Polaris chain lube or SAE 80-90 lube. See page 106 for the part numbers of Polaris products.

CAUTION

Washing the drive chain with a high pressure washer or gasoline can cause damage to the o-rings, causing premature wear and drive chain failure. Don't use a high pressure washer or gasoline to clean the drive chain.

Cylinder Head/Cylinder Base Fastener

Have your dealer check the ATV cylinder head and cylinder base fasteners for proper torque at the first service or after 25 hours.

MAINTENANCE AND LUBRICATION

Adjustments

Rear Drive Chain Slack

CAUTION

Adjusting or operating the ATV with improper rear drive chain slack can result in severe damage to the transmission and drive components. Always make sure the slack is within the stated specifications.

Check the amount of chain slack in three different locations by moving the vehicle slightly forward. Measure the chain slack at the tightest of the three positions. At this point the chain should have 3/16" - 3/8" (.48 cm - .95 cm) deflection. Use the following procedure if adjustment is required.

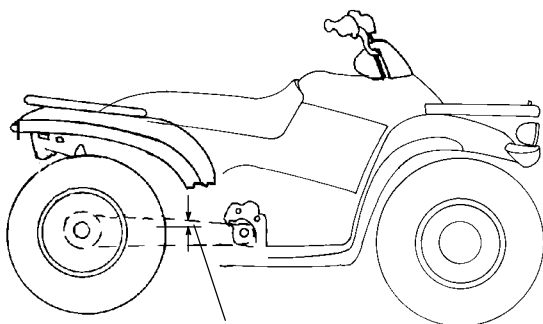

3/16" - 3/8" (.48 cm - .95 cm)

1. Loosen the chain guide.
2. Loosen the two eccentric locking bolts (1).
3. Loosen the caliper mounting bolt located on the left side of the swing arm.
4. Insert a pin punch (2) through the sprocket hub and into the eccentric housing.

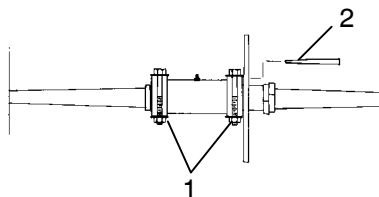

MAINTENANCE AND LUBRICATION

Adjustments

Rear Drive Chain Slack

1. Roll the ATV forward or backward to adjust the chain slack to the proper tension. See the illustration for proper splice link clip opening position (1).
2. Tighten the eccentric locking bolts to 30 ft. lbs. (41 Nm) for machines without the hitch and 45 ft. lbs. (61 Nm) for machines with a hitch.
3. Tighten the caliper mount bolt to 15 ft. lbs. (20 Nm).
4. Remove the pin punch.
5. Roll the ATV forward, checking chain tension in several places around the chain.

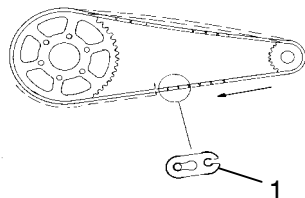

- NOTE:** The chain is adjusted correctly when the tightest portion of the chain has approximately $3/8$ " (10mm) deflection.
6. Position the chain guide to allow $1/8$ " (3mm) clearance and tighten the retaining bolt to 5 ft. lbs. (7 Nm).
 7. Reinstall the chain guard if applicable.

MAINTENANCE AND LUBRICATION

Filter Systems

Air Filter Removal and Service

1. Remove the ATV seat.
2. Release the clips securing the cover assembly to the air box.
3. Loosen the clamp securing the filter, and remove the filter.
4. Remove the foam pre-filter from the main filter.
5. Wash the pre-filter in soapy water, then rinse and let dry.
6. Re-install the pre-filter over the main filter. (Replace the main filter if needed.)

Air Filter Installation

1. Check the condition of the air box and replace if necessary.
2. Replace the filter over the carburetor boot. Make sure the filter is fully seated in the air box.
3. Tighten the clamp. Do not overtighten, as filter damage could occur.
4. Check the cover gasket and replace if needed. Be sure the cover is seated properly, then snap the clips onto the cover.
5. Reinstall the ATV seat.

Air Filter Cleaning

Check and replace the air filter at the intervals outlined in the Periodic Maintenance Chart beginning on page 65.

NOTE: Always replace the main filter when it becomes dirty. In an emergency situation, however, you may clean the main filter if you observe the following practices.

1. *Never* immerse the main filter in water. Dirt can be transferred to the clean air side of the filter.
2. If compressed air is used for cleaning, *never* exceed a pressure of 40 PSI. Always use a dispersion-type nozzle to prevent filter damage, and blow the air from the inside to the outside.

MAINTENANCE AND LUBRICATION

Lights

When servicing a halogen lamp, don't touch the lamp with bare fingers. Oil from your skin leaves a residue, causing a hot spot that will shorten the life of the lamp.

WARNING

Poor lighting while driving can result in severe injury or death. Headlight and taillight lenses become dirty during normal operation. Wash the headlights frequently to maintain lighting quality.

Hot components can cause serious burns to skin. Do not service the headlamps until they've cooled sufficiently.

Headlight Lamp Replacement

1. Remove the front cover and unplug the light harness.
2. Remove the rubber cap from the back of the headlight to reveal the retention screw.
3. Remove the small phillips head screw, and carefully remove the bulb from the housing.
4. Insert the new bulb into the housing and reinstall the retention screw. Reinstall the rubber cap.
5. Reconnect the light harness and reinstall the cover.
6. Adjust the headlight aim if necessary.

MAINTENANCE AND LUBRICATION

Lights

Headlight Adjustment

1. Position the vehicle on a level surface with the headlight approximately 25 ft. (7.6 m) from a flat wall.
2. Measure the distance from the floor to the center of the headlight and make a mark on the wall at the same height.
3. Start the engine and turn on the headlight.
4. Observe the headlight aim on the wall. The most intense part of the headlight beam should be aimed 8" (20.3 cm) below the mark placed on the wall.

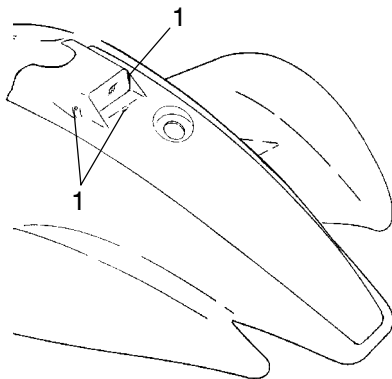

NOTE: Include rider weight on the seat when measuring.

5. Adjust the beam to the desired position by turning the adjustment screws (1):
 - Turning the right screw clockwise moves the intense spot of light up and to the left.
 - Turning the left screw clockwise moves the intense spot of the light up and to the right.
 - Turning the bottom screw clockwise adjusts the light upward.

MAINTENANCE AND LUBRICATION

Lights

Taillight/Brakelight Lamp Replacement

If the taillight/brakelight does not work the lamp may need to be replaced.

1. Remove the taillight lens cover mounting screws. Remove the lens cover and gasket and set aside for reassembly.
2. Remove the lamp (1). Apply dielectric grease to the socket and install the new lamp.
3. Test the taillight/brakelight to see that it's working.
4. Reinstall the gasket and lens cover.

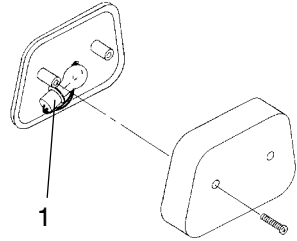

Indicator Lamp Replacement

1. Remove the instrument panel, if necessary, to access the back of the indicator panel.
2. Using a small, straight-blade screwdriver, turn the base of the bulb 1/4 turn counterclockwise.
3. Using a needle-nose plier or similar tool, pull the lamp out of the indicator panel housing.
4. Insert the new bulb and seat it by turning it 1/4 turn clockwise.
5. Reassemble the pod or front cover.

MAINTENANCE AND LUBRICATION

Spark Plugs

Always use the spark plugs recommended for your ATV. Refer to the specifications section beginning on page 103 for the recommended spark plug type and gap.

CAUTION

Using non-recommended spark plugs can result in serious engine damage. Always use Polaris-recommended spark plugs.

Spark plug condition is indicative of engine operation. The spark plug firing end condition should be read after the engine has been warmed up and the vehicle has been driven at higher speeds. Immediately check the spark plug for correct color.

WARNING

A hot exhaust system and engine can cause serious burns. Wear protective gloves when removing a spark plug for inspection.

1. Normal

The normal insulator tip is gray, tan or light brown. There will be few combustion deposits. The electrodes are not burned or eroded. This indicates the proper type and heat range for the engine and the service.

NOTE: The tip should not be white. A white insulator tip indicates overheating, caused by use of an improper spark plug or incorrect carburetion adjustments.

2. Wet Fouled

The wet fouled insulator tip is black. A damp oil film covers the firing end. There may be a carbon layer over the entire nose. Generally, the electrodes are not worn. General causes of fouling are excessive oil, use of non-recommended injection oil, improper use of the choke, or incorrect carburetion adjustments.

Spark Plug Removal and Replacement

1. Remove the spark plug cap.
2. Using the special wrench provided in the tool pouch, rotate the spark plug counterclockwise to remove.
3. Reverse the procedure for spark plug installation. Torque to 14 ft. lbs. (19 Nm).

MAINTENANCE AND LUBRICATION

Vehicle Immersion

CAUTION

If your vehicle becomes immersed, major engine damage can result if the machine is not thoroughly inspected. Take the vehicle to your dealer before starting the engine.

If it's impossible to take your ATV to a dealer before starting it, follow the steps outlined below.

1. Move the ATV to dry land or at the very least, to water below the foot rests.
2. Check the airbox for any water. Drain and dry it if water is present.
3. Turn the fuel valve off.
4. Remove the spark plug.
5. Remove the bowl drain (1).
6. Remove the crankcase drain screw at the left front of the engine bottom.
7. Turn the engine over several times using the electric start.
8. Dry the spark plug and reinstall, or replace it with a new plug.
9. Reinstall the bowl drain.
10. Reinstall the crankcase drain screw.
11. Turn the fuel valve on.
12. Attempt to start the engine. If necessary, repeat the drying procedure.
13. Take the ATV to your dealer for service as soon as possible, whether you succeed in starting it or not.

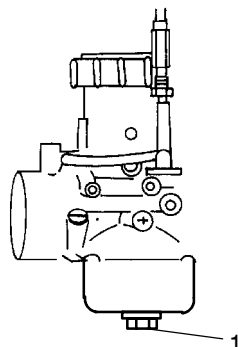

NOTE: If water has been ingested into the PVT, follow the procedure on page 95 for drying out the PVT.

MAINTENANCE AND LUBRICATION

Spark Arrestor

WARNING

Failure to heed the following warnings while servicing the spark arrestor could result in serious injury or death.

Do not perform service on the spark arrestor while the system is hot. Exhaust system temperatures can reach 1000° F. Allow components to cool sufficiently before proceeding.

Remove any combustible materials from the area. Wear eye protection and leather work gloves. Do not stand behind or in front of the vehicle while purging. Never run the engine in an enclosed area. Exhaust contains poisonous carbon monoxide gas. Never go under the vehicle while it's inclined.

1. Remove the arrestor clean-out plug (1) from the bottom of the muffler.
2. Place the transmission in neutral and start the engine.
3. Purge carbon from the system by momentarily revving the engine several times.
4. If carbon is expelled, cover or plug the exhaust outlet (2) and rap on the pipe around the cleanout plug while revving the engine several more times.
5. If particles are still suspected to be in the muffler, elevate the rear of the vehicle one foot higher than the front. Set the parking brake and block the wheels. Make sure the vehicle is in neutral and repeat steps 3 and 4 until no more particles are expelled when the engine is revved.
6. Stop the engine and allow the arrestor to cool. Reinstall the arrestor plug and remove the outlet cover or plug.

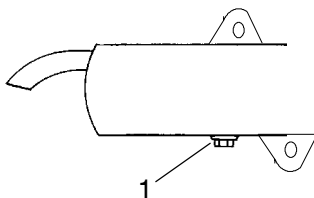

MAINTENANCE AND LUBRICATION

Recoil Housing

To prevent possible engine damage, always drain the recoil housing (1) after operating the ATV in very wet conditions. This should also be done before storing the ATV.

Water will enter the recoil housing if the starter handle is disengaged from the rope guide when under water. The recoil handle *must be behind the heat shield* for it to seal properly.

The drain screw is located at the bottom of the recoil housing. Use a wrench to remove the screw. Be sure to reinstall the screw after draining the housing.

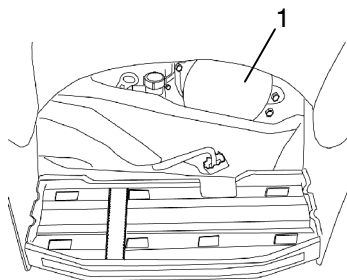

MAINTENANCE AND LUBRICATION

PVT System

The basic operation of the Polaris PVT system is dependent on engine speed and vehicle torque requirements. As engine speed increases, the force exerted on the movable drive sheave by the flyweights also increases. This, in turn, increases the amount of “pinch” applied to the drive belt. Similarly, if the engine speed decreases, the amount of centrifugal force decreases, reducing the amount of belt “pinch.” This begins to occur at speeds of less than 5 MPH, due to the system’s dependence on engine speed.

For example, when operating at a ground speed of 3 MPH, the engine would be running at only about 1500 RPM, with an engagement speed of about 1400 RPM. Whenever operating this close to the engagement point, the engine may be running at a speed too low to provide the adequate “pinch” needed to prevent incomplete engagement.

Incomplete engagement creates excessive heat that can destroy belts and clutch covers. In some cases, excessive clutch wear and damage may result.

If the ATV will be operated for extended periods below 5 MPH, or for towing loads, we recommend that you install a one tooth smaller counter shaft sprocket to raise the operating RPM far enough above the engagement RPM to reduce heat caused by incomplete engagement. Reducing the temperature inside the clutch cover extends the life of the PVT components (belt, cover, etc.).

NOTE: Avoid heavy pulling and extended low-speed operation.

MAINTENANCE AND LUBRICATION

PVT System

WARNING

Failure to comply with the instructions in this warning can result in severe injury or death.

Do not modify any component of the PVT system. Doing so may reduce its strength so that a failure may occur at a high speed. The PVT system has been precision balanced. Any modification will cause the system to be out of balance, creating vibration and additional loads on components.

The PVT system rotates at high speeds, creating large amounts of force on clutch components. Extensive engineering and testing has been conducted to ensure the safety of this product. However, as the owner, you have the following responsibilities to make sure this system remains safe:

Always follow all recommended maintenance procedures. See your dealer as outlined in the owner's manual.

This PVT system is intended for use on Polaris products only. Do not install it in any other product.

Always make sure the PVT housing is securely in place during operation.

PVT Drying

There may be some instances when water is accidentally ingested into the PVT system. Use the following instructions to dry it out before operating:

1. Remove the drain plug and allow the water to drain. Replace the drain plug.
2. Start the engine and shift the transmission into neutral. Apply varying throttle for 10-15 seconds to expel the moisture and air-dry the belt and clutches. Do not hold the throttle wide open for more than 10 seconds.
3. Allow the engine RPM to settle to idle speed, then shift the transmission to the lowest available range.
4. Test for belt slippage. If the belt slips, repeat the process.
5. Take the vehicle to your dealer for service as soon as possible.

MAINTENANCE AND LUBRICATION

Battery

WARNING

Improperly connecting or disconnecting battery cables can result in an explosion and cause serious injury or death. When removing the battery, always disconnect the negative (black) cable first. When reinstalling the battery, always connect the negative (black) cable last.

Battery Removal

1. Disconnect the battery hold-down strap and remove the battery cover.
2. Disconnect the black (negative) battery cable first.
3. Disconnect the red (positive) battery cable next.
4. Lift the battery out of the ATV.

Battery Installation

When installing a new battery, make sure it's fully charged prior to its initial use. Using a new battery that has not been fully charged can damage the battery and result in a shorter life. It can also hinder vehicle performance. Follow the battery charging instructions on page 97 before installing the battery.

1. Ensure that the battery is fully charged.
2. Set the battery in the battery holder.
3. Connect and tighten the red (positive) cable first.
4. Connect and tighten the black (negative) cable last.
5. Reinstall the battery cover and attach the hold-down strap.
6. Verify that cables are properly routed.

MAINTENANCE AND LUBRICATION

Battery

Battery Storage

Whenever the vehicle is not used for a period of three months or more, remove the battery from the vehicle, ensure that it's fully charged, and store it out of the sun in a cool, dry place. Check battery voltage each month during storage and recharge as needed to maintain a full charge.

NOTE: Battery charge can be maintained by using a Polaris Battery Tender™ charger (PN 2871076) or by charging about once a month to make up for normal self-discharge. Battery Tender™ can be left connected during the storage period, and will automatically charge the battery if the voltage drops below a pre-determined point.

Battery Charging

The following battery charging instructions apply only to the installation of a sealed battery. Read all instructions before proceeding with the installation of this battery.

The sealed battery is already filled with electrolyte and has been sealed and *fully charged* at the factory. *Do not ever* pry the sealing strip off or add any other fluid to this battery.

The single most important thing about maintaining a sealed battery is to keep it fully charged. Since the battery is sealed and the sealing strip cannot be removed, you must use a voltmeter or multimeter to measure DC voltage.

For a refresh charge, follow all instructions carefully.

1. Check the battery voltage with a voltmeter or multimeter. A fully charged battery will register 12.8 V or higher.
2. If the voltage is less than 12.8 volts, recharge the battery at 1.2 amps or less until the battery voltage is 12.8 or greater.

NOTE: When using an automatic charger, refer to the charger manufacturer's instructions for recharging. When using a constant current charger, use the following guidelines for recharging.

WARNING

An overheated battery may explode, causing severe injury or death. Always watch charging times carefully. Stop charging if the battery becomes very warm to the touch. Allow it to cool before resuming charging.

MAINTENANCE AND LUBRICATION

Battery

Battery Charging

NOTE: Always verify battery condition before and 1-2 hours after the end of charging.

State of Charge	Voltage	Action	Charge Time* <small>(Using constant current charger @ standard amps specified on top of battery)</small>
100%	12.8-13.0 volts	None, check at 3 mos. from date of manufacture	None required
75%-100%	12.5-12.8 volts	May need slight charge, if no charge given, check in 3 months	3-6 hours
50%-75%	12.0-12.5 volts	Needs charge	5-11 hours
25%-50%	11.5-12.0 volts	Needs charge	At least 13 hours, verify state of charge
0%-25%	11.5 volts or less	Needs charge with desulfating charger	At least 20 hours

MAINTENANCE AND LUBRICATION

Cleaning and Storage

See page 106 for the part numbers of Polaris products.

Cleaning the ATV

Keeping your ATV clean will not only improve its appearance but it can also extend the life of various components. With a few precautions, your ATV can be cleaned much like an automobile.

Washing the ATV

The best and safest way to clean your ATV is with a garden hose and a pail of mild soap and water. Use a professional type washing mitten, cleaning the upper body first and the lower parts last. Rinse with water frequently and dry with a chamois to prevent water spots.

NOTE: If warning and safety labels are damaged, contact your a Polaris dealer for free replacement.

Polaris does not recommend the use of a high pressure type car wash system for washing the ATV. If a high pressure system is used, exercise extreme care to avoid water damage to the wheel bearings, transmission seals, body panels, brakes, warning labels and decals.

NOTE: Grease all zerk fittings immediately after washing, and allow the vehicle to run for a while to evaporate any water that may have entered the engine or exhaust system.

Waxing the ATV

Your ATV can be waxed with any non-abrasive automotive paste wax. Avoid the use of harsh cleaners since they can scratch the body finish.

CAUTION

Certain products, including insect repellants and chemicals, will damage plastic surfaces. Use caution when using these products near plastic surfaces.

MAINTENANCE AND LUBRICATION

Cleaning and Storage

Storage Tips

See page 106 for the part numbers of Polaris products.

CAUTION

Starting the engine during the storage period will disturb the protective film created by fogging and damage could occur. Never start the engine during the storage period.

Exterior

Make necessary repairs and then clean the ATV thoroughly with mild soap and warm water to remove all dirt and grime. Don't use harsh detergents or high pressure washers. Some detergents deteriorate rubber parts. Use dish soap type cleaners only. High pressure washers may force water past seals.

Fuel Stabilizer

Polaris Carbon Clean is a fuel stabilizer and fuel system dryer. It cleans the fuel system, the combustion chamber and the exhaust ports. It also prevents bacterial growth and promotes better starting after the storage period.

1. Fill the fuel tank with fuel and add Polaris Carbon Clean or Fuel Stabilizer. Follow the instructions on the container for the recommended amounts.
2. Start the engine and allow it to run for 15-20 minutes so the stabilizer can disperse through the fuel in the tank and carburetor.
3. Stop the engine, turn the fuel valve off, and drain the carburetor bowl.

Air Filter / Air Box

Inspect and clean or replace the pre-cleaner and air filter. Clean the air box and drain the sediment tube.

Recoil Housing

Remove the recoil housing drain plug and drain any moisture.

Fluid Levels

Inspect the following fluid levels and change if necessary: engine oil; transmission oil; brake fluid (change every two years or as needed if fluid looks dark or contaminated).

MAINTENANCE AND LUBRICATION

Cleaning and Storage

Storage Tips

See page 106 for the part numbers of Polaris products.

Engine

Use Polaris Fogging Oil and follow the directions on the can.

If you choose not to use Polaris Fogging Oil, perform the following procedure.

1. Support the front end of the machine so the engine is level or tilted slightly rearward.
2. Remove the spark plug. Rotate the piston to BDC and pour approximately two ounces of the recommended oil into the cylinder. Reinstall the spark plug.
3. Apply dielectric grease to the inside of the spark plug cap and install the cap onto the plug.
4. With the ignition *off*, turn the engine over several times using the recoil starter. This will ensure coverage of the piston rings, cylinder walls and crankshaft bearings.
5. Treat the fuel system with Polaris Carbon Clean.
6. If Polaris fuel system additive is not used, fuel tank, fuel lines, and carburetor should be completely drained of gasoline.

Lubricate

Inspect all cables and lubricate with Polaris Cable Lubricant. Follow lubrication guidelines in the maintenance section of the service or owner's manual to completely grease and lubricate the entire vehicle with Polaris Premium All Season Grease. Apply Polaris O-Ring Chain Lube to the drive chain.

Battery Storage

Remove the battery from the vehicle and ensure that it's fully charged before placing it in storage. See page 97 for instructions.

Storage Area/Covers

Set the tire pressure and safely support the ATV with the tires 1-2" off the ground. Be sure the storage area is well ventilated, and cover the machine with a genuine Polaris ATV cover.

NOTE: Do not use plastic or coated materials. They do not allow enough ventilation to prevent condensation, and may promote corrosion and oxidation.

MAINTENANCE AND LUBRICATION

Cleaning and Storage

Chrome Wheel Care (if equipped)

Proper maintenance will protect chrome wheels from corrosion, preserve wheel life and ensure a “like new” appearance for many years.

1. Wash chrome rims frequently. Use a mild detergent to remove any salt, dirt, mud or grime. Never use abrasive cleaners on plated or painted surfaces.
2. Polish the clean chrome wheels periodically. Use an automotive grade chrome polish.
3. Routinely and liberally apply a weather resistant wax to each polished chrome wheel. Choose a product suitable for chrome finishes. Read and follow the product labels and instructions.
4. Chrome wheels exposed to road salt (or salt in the air in coastal areas) are more susceptible to corrosion if not properly cleaned. Clean chrome wheels more often if they’re exposed to salt or other corrosive elements.

Removing Corrosion

If light rust is found on the chrome finish, use steel wool (#0000-OTT grade) to remove it. Gently rub the affected areas with the steel wool until the corrosion has been removed. Clean and polish the wheel as outlined above.

Transporting an ATV

Follow these procedures when transporting an ATV.

1. Turn off the engine and remove the key to prevent loss during transporting.
2. Turn the fuel valve off.
3. Be sure the fuel cap, oil cap and seat are installed correctly and securely.
4. Always tie the *frame* of the ATV to the transporting unit securely using suitable straps or rope. The rack, bumper or handlebars do not offer enough support for tie-down while transporting the unit.
5. Always place the transmission in gear and lock the parking brake.

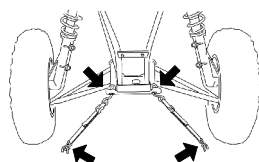
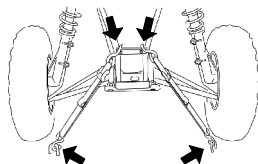
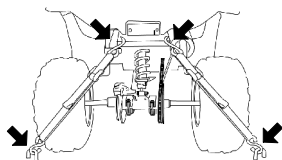

SPECIFICATIONS

2005 Trail Blazer

<i>Capacities</i>	
Body Style	Gen III
Gross Vehicle Weight	765 lbs. (347 kg)
Fuel Capacity	3.5 U.S. gal. (13.2 l)
Engine Oil	2 qts. (1.89 l)
Transmission Oil	11.3 oz. (.33 l)
Front Rack (Accessory) (Maximum Capacity)	30 lbs. (13.6 kg)
Rear Rack (Accessory)	60 lbs. (27.2 kg)
Tongue Weight	85 lbs. (38.5 kg)
Tow Hitch	Accessory
Tow Capacity	850 lbs. (385.5 kg)
Turn Radius	63 in. (160 cm)
Ground Clearance	5.5 (14 cm)
Height	47 in. (119.4 cm)
Length	75 in. (190.5 cm)
Seat Height	34 in. (86.4 cm)
Dry Weight	461 lbs. (209.1 kg)
Wheel Base	48 in. (121.9 cm)
Width	46 in. (116.8 cm)
<i>Engine & Cooling</i>	
Engine Model Number / Type	EC-25PFE-154 / 2 Cycle, Single Cylinder
Lubrication	Oil Injection
Bore x Stroke	72 x 60
Displacement	244cc
Compression Ratio	6.1/1 Effective
Engine Cooling	Air
Alternator Output	150 watts @ 4000 RPM
Carburetion	1/VM30SS
Main Jet	130 (hex)
Pilot Jet	40
Needle Jet	0-4 (169)
Pilot Screw	1.0
Jet Needle	5DP7-3
Ignition	CDI
Timing	25° ± 3° @ 3000
Spark Plug Type / Gap	NGK BR8ES / .028 in. (.7 mm)

SPECIFICATIONS

2005 Trail Blazer

<i>Drive System</i>	
Drive System Type	PVT
Shift Type	Side Lever (F-N-R)
Gear Reduction - Low	Not Applicable
Gear Reduction - Reverse	3.05/1
Gear Reduction - Forward	2.68/1
Front Drive (ratio)	Not Applicable
Final Drive (ratio)	11/36 76P
Center Drive (ratio)	Not Applicable
Drive Chain	520 O-Ring
Front Tire	23 x 7-10 (4 psi)
Rear Tire	22 x 11-10 (3 psi)
<i>Suspension and Brakes</i>	
Front Suspension	McPherson Strut w/8.2" (20.8 cm) travel
Rear Suspension	Progressive Rate w/10.5" (26.7 cm) travel
Shock Adjustment	CAM
Front Brake	Hydraulic Disc
Rear Brake	Hydraulic Disc
Auxiliary Brake	Hydraulic Disc
Park Brake	Hydraulic lock, all wheel
<i>Features</i>	
Headlight	1 Single Beam (55 w)
Taillight	8.26 w
Brake Light	26.9 w
Battery	12V 14 AH
DC Plug-In (Rear)	Accessory
DC Socket (Forward)	Accessory
Electric Start	Standard
High Temp Indicator	Not Available
Windshield	Accessory
Low Oil Light	Standard
Neutral Indicator	Standard
Reverse Indicator	Standard
Speedometer	Accessory
Fuel Gauge	Standard
Tool Kit	Standard

SPECIFICATIONS

2005 Trail Blazer

Jetting Chart

Altitude	Ambient Temperature	Below 0°F (Below -18°C)	0° to 40°F (-18°C to +5°C)	+40° to +80°F (+5°C to +26°C)	+80°F & Above (+26°C & Above)
Meters (Feet)	0-900 (0-3000)	150	140	130	120
	900-1800 (3000-6000)	140	130	120	110
	1800-2700 (6000-9000)	125	120	110	100
	2700-3700 (9000-12000)	115	110	100	95



Turn air screw out 1/2 turn CCW from seat. Raise needle clip 1 position to lower jet needle.

Clutching Chart

Altitude		Shift Weight	Drive Clutch Spring	Driven Clutch Spring	Helix/Spring Setting
Meters (Feet)	0-1800 (0-6000)	G (5630514)	Blue/Green (7041157)	Red (7041198)	40° (5131446) 2+2
	1800-3700 (6000-12000)	F (5630515)	Blue/Green (7041157)	Red (7041198)	40° (5131446) 2+2

POLARIS PRODUCTS

Part No.	Description
Engine Lubricant	
2870791	Fogging Oil (12 oz. Aerosol)
2871098	Premium Blue 2-Cycle Mineral Oil (qt.)
2871097	Premium Blue 2-Cycle Mineral Oil (gal.)
2871721	Premium Gold Synthetic 2-Cycle Oil (qt.)
2871722	Premium Gold Synthetic 2-Cycle Oil (gal.)
2874438	VES II Synthetic 2-Cycle Oil (qt.)
2874439	VES II Synthetic 2-Cycle Oil (gal.)
Gearcase / Transmission Lubricants	
2873602	Premium AGL Synthetic Gearcase Lube (qt.)
2873603	Premium AGL Synthetic Gearcase Lube (gal.)
2870465	Pump for Gallon Jug
Grease / Specialized Lubricants	
2871322	Premium All Season Grease (3 oz. cartridge)
2871423	Premium All Season Grease (14 oz. cartridge)
2871460	Starter Drive Grease
2871312	Grease Gun Kit
2871329	Dielectric Grease (Nyogel™)
2872073	Chain Lube (6.25 oz. aerosol)
2872348	Chain Lube (16 oz. aerosol)
Additives / Miscellaneous	
2872889	Brake and Clutch Cleaner
2871326	Carbon Clean Plus (12 oz.)
2870652	Fuel Stabilizer (16 oz.)
2870990	DOT3 Brake Fluid
2872893	Engine Degreaser

TROUBLESHOOTING

Drive Belt and Cover Problems

Possible Cause	Solution
Driving the ATV onto a pickup or tall trailer in high range.	Avoid stopping on the ramp or creeping slowly up the ramp. These practices may slip the clutch and belt.
Starting out going up a steep incline.	When starting out on an incline, use low range or dismount the ATV (after first applying the park brake) and perform the K-turn as described on page 55.
Driving at low RPM or low ground speed (at approximately 3-7 MPH).	Drive at a higher speed. Avoid creeping.
Insufficient warm-up of ATVs exposed to low ambient temperatures.	Warm the engine at least 5 minutes. With the transmission in neutral, advance the throttle to about 1/8 throttle in short bursts, 5 to 7 times. The belt will become more flexible and prevent belt burning.
Slow and easy clutch engagement.	Use the throttle quickly and effectively for efficient engagement.
Towing/pushing at low RPM/low ground speed.	Install a one tooth smaller counter shaft sprocket.
Stuck in mud or snow.	Carefully use fast, aggressive throttle application to engage clutch. WARNING: Excessive throttle may cause loss of control and vehicle overturn.
Climbing over large objects from a stopped position.	Carefully use fast, brief, aggressive throttle application to engage clutch. WARNING: Excessive throttle may cause loss of control and vehicle overturn.
Belt slippage from water or snow ingestion into the PVT system.	Dry out the PVT as outlined on page 95. Inspect clutch seals for damage if repeated leaking occurs.
Clutch malfunction.	Contact your Polaris dealer for inspection of clutch components.
Poor engine performance.	Check for fouled plugs or foreign material in gas tank, fuel lines, or carburetor. Contact your dealer for service.

TROUBLESHOOTING

Contact your Polaris dealer for service if you're unable to identify solutions using the following charts.

Engine Doesn't Turn Over

Possible Cause	Solution
Low battery voltage	Recharge battery to 12.8 VDC
Loose battery connections	Check all connections and tighten
Loose solenoid connections	Check all connections and tighten

Engine Turns Over, Fails to Start

Possible Cause	Solution
Out of fuel	Turn fuel valve to reserve, refuel
Clogged fuel valve or filter	Inspect and clean or replace
Water is present in fuel	Drain the fuel system and refuel
Fuel valve is turned off	Turn the fuel valve on
Old or non-recommended fuel	Replace with new fuel
Fouled or defective spark plug(s)	Inspect plug(s), replace if necessary
No spark to spark plug	Inspect plug(s), verify stop switch is on
Crankcase filled with water or fuel	Immediately see your Polaris dealer
Overuse of choke	Inspect, clean and/or replace spark plugs
Clogged fuel filter	Replace the filter
Low battery voltage	Recharge battery to 12.8 VDC
Mechanical failure	See your Polaris dealer

Engine Pings or Knocks

Possible Cause	Solution
Poor quality or low octane fuel	Replace with recommended fuel
Incorrect ignition timing	See your Polaris dealer
Incorrect spark plug gap or heat range	Set gap to specs or replace plugs

TROUBLESHOOTING

Engine Backfires

Possible Cause	Solution
Weak spark from spark plugs	Inspect, clean and/or replace spark plugs
Incorrect spark plug gap or heat range	Set gap to specs or replace plugs
Old or non-recommended fuel	Replace with new fuel
Incorrectly installed spark plug wires	See your Polaris dealer
Incorrect ignition timing	See your Polaris dealer
Mechanical failure	See your Polaris dealer

Engine Runs Irregularly, Stalls or Misfires

Possible Weak Spark Cause	Solution
Fouled or defective spark plugs	Inspect, clean and/or replace spark plugs
Worn or defective spark plug wires	See your Polaris dealer
Incorrect spark plug gap or heat range	Set gap to specs or replace plugs
Loose ignition connections	Check all connections and tighten
Water present in fuel	Replace with new fuel
Low battery voltage	Recharge battery to 12.8 VDC
Kinked or plugged fuel vent line	Inspect and replace
Incorrect fuel	Replace with recommended fuel
Clogged air filter	Inspect and clean or replace
Reverse speed limiter malfunction	See your Polaris dealer
Electronic throttle control malfunction	See your Polaris dealer
Other mechanical failure	See your Polaris dealer
Possible Lean Fuel Mixture Cause	Solution
Low or contaminated fuel	Add or change fuel, clean the fuel system
Low octane fuel	Replace with recommended fuel
Clogged fuel filter	Replace filter
Incorrect jetting	See your Polaris dealer
Possible Rich Fuel Mixture Cause	Solution
Overuse of choke	Inspect, clean and/or replace spark plugs
Fuel is very high octane	Replace with lower octane fuel
Incorrect jetting	See your Polaris dealer

TROUBLESHOOTING

Engine Stops or Loses Power

Possible Cause	Solution
Out of fuel	Turn fuel valve to reserve, refuel
Kinked or plugged fuel vent line	Inspect and replace
Water present in fuel	Replace with new fuel
Overuse of choke	Inspect, clean and/or replace spark plugs
Fouled or defective spark plugs	Inspect, clean and/or replace spark plugs
Worn or defective spark plug wires	See your Polaris dealer
Incorrect spark plug gap or heat range	Set gap to specs or replace plugs
Loose ignition connections	Check all connections and tighten
Low battery voltage	Recharge battery to 12.8 VDC
Incorrect fuel	Replace with recommended fuel
Clogged air filter	Inspect and clean or replace
Reverse speed limiter malfunction	See your Polaris dealer
Electronic throttle control malfunction	See your Polaris dealer
Other mechanical failure	See your Polaris dealer
Overheated engine	Clean engine exterior See your Polaris dealer

WARRANTY

LIMITED WARRANTY

Polaris Sales Inc., 2100 Highway 55, Medina, MN 55340, gives a SIX MONTH LIMITED WARRANTY on all components of the Polaris All Terrain Vehicle (ATV) against defects in material or workmanship. Polaris also gives a one year limited warranty on the final drive chain for failure due to defects. This warranty covers the parts and labor charges for repair or replacement of defective parts which are covered by this warranty. This warranty begins on the date of purchase. This warranty is transferrable to another consumer during the warranty period through a Polaris dealer.

REGISTRATION

At the time of sale, the Warranty Registration Form must be completed by your dealer and submitted to Polaris within ten days. Upon receipt of this registration, Polaris will record the registration for warranty. **THE PURCHASER MUST COMPLETE AN ATV SAFETY TRAINING COURSE PROVIDED BY THE DEALER IN ORDER TO HAVE VALID WARRANTY ON THE ATV.** No verification of registration will be sent to the purchaser as the copy of the Warranty Registration Form will be the warranty entitlement. If you have not signed the original registration and received the “customer copy”, please contact your dealer immediately. **NO WARRANTY COVERAGE WILL BE ALLOWED UNLESS YOUR ATV IS REGISTERED WITH POLARIS.**

Initial dealer preparation and set-up of your ATV is very important in ensuring trouble-free operation. Purchasing a machine in the crate or without proper dealer set-up will void your warranty coverage.

WARRANTY COVERAGE AND EXCLUSIONS:

LIMITATIONS OF WARRANTIES AND REMEDIES

The Polaris limited warranty excludes any failures that are not caused by a defect in material or workmanship. This warranty does not cover accidental damage, normal wear and tear, abuse or improper handling. This warranty also does not cover any ATV that has been altered structurally, modified, neglected, improperly maintained, used for racing, or used for purposes other than for which it was manufactured, or for any damages which occur during trailer transit or as a result of unauthorized service or the use of unauthorized parts. In addition, this warranty does not cover physical damage to paint or finish, stress cracks, tearing or puncturing of upholstery material, corrosion, or defects in parts, components or the ATV due to fire, explosions or any other cause beyond Polaris' control.

This warranty does not cover the use of unauthorized lubricants, chemicals, or fuels that are not compatible with the ATV. The exclusive remedy for breach of this warranty shall be, at Polaris' exclusive option, repair or replacement of any defective materials, or components or products. **THE REMEDIES SET FORTH IN THIS WARRANTY ARE THE ONLY REMEDIES AVAILABLE TO ANY PERSON FOR BREACH OF THIS WARRANTY. POLARIS SHALL HAVE NO LIABILITY TO ANY PERSON FOR INCIDENTAL, CONSEQUENTIAL OR SPECIAL DAMAGES OF ANY DESCRIPTION, WHETHER ARISING OUT OF EXPRESS OR IMPLIED WARRANTY OR ANY OTHER CONTRACT, NEGLIGENCE, OR OTHER TORT OR OTHERWISE.** Some states do not permit the exclusion or limitation of incidental or consequential damages or implied warranties, so the above limitations or exclusions may not apply to you if inconsistent with controlling state law.

WARRANTY

WARRANTY COVERAGE AND EXCLUSIONS:

LIMITATIONS OF WARRANTIES AND REMEDIES

ALL IMPLIED WARRANTIES (INCLUDING BUT NOT LIMITED TO THE IMPLIED WARRANTIES OF MERCHANTABILITY AND FITNESS FOR A PARTICULAR PURPOSE) ARE LIMITED IN DURATION TO THE ABOVE SIX MONTH WARRANTY PERIOD. POLARIS FURTHER DISCLAIMS ALL EXPRESS WARRANTIES NOT STATED IN THIS WARRANTY. Some states do not allow limitations on how long an implied warranty lasts, so the above limitation may not apply to you if inconsistent with controlling state law.

HOW TO OBTAIN WARRANTY SERVICE

If your ATV requires warranty service, you must take it to a Polaris dealer authorized to repair Polaris ATVs. When requesting warranty service you must present your copy of the Warranty Registration form to the dealer. (THE COST OF TRANSPORTATION TO AND FROM THE DEALER IS YOUR RESPONSIBILITY). Polaris suggests that you use your original selling dealer; however, you may use any Polaris Servicing Dealer to perform warranty service.

Please work with your dealer to resolve any warranty issues. Should your dealer require any additional assistance they will contact the appropriate personnel at Polaris.

This warranty gives you specific legal rights, and you may also have other rights which vary from state to state.

If any of the above terms are void because of state or federal law, all other warranty terms will remain in effect.

Engine Oil

1. Mixing oil brands or using non-recommended oil may cause engine damage. We recommend the use of Polaris engine oil.
2. Damage resulting from the use of non-recommended lubricants may not be covered by warranty.

Exported Vehicles

EXCEPT WHERE SPECIFICALLY REQUIRED BY LAW, THERE IS NO WARRANTY OR SERVICE BULLETIN COVERAGE ON THIS VEHICLE IF IT IS SOLD OUTSIDE THE COUNTRY OF THE SELLING DEALER'S AUTHORIZED LOCATION.

This policy does not apply to vehicles that have received authorization for export from Polaris Industries. Dealers may not give authorization for export. You should consult an authorized dealer to determine this vehicle's warranty or service bulletin coverage if you have any questions.

This policy does not apply to vehicles registered to government officials or military personnel on assignment outside the country of the selling dealer's authorized location.

This policy does not apply to Safety Recalls.

How to Get Service

In the Country where your vehicle was purchased:

Warranty or Service Bulletin repairs must be done by an authorized Polaris dealer. If you move or are traveling within the country where your vehicle was purchased, Warranty or Service Bulletin repairs may be requested from any authorized Polaris dealer who sells the same line as your vehicle.

Outside the Country where your vehicle was purchased:

If you are traveling temporarily outside the country where your vehicle was purchased, you should take your vehicle to an authorized Polaris dealer. You must show the dealer photo identification from the country of the selling dealer's authorized location as proof of residence. Upon residence verification, the servicing dealer will be authorized to perform the warranty repair.

If You Move:

If you move to another country, be sure to contact Polaris Customer Assistance and the customs department of the destination country before you move. Vehicles importation rules vary considerably from country to country. You may be required to present documentation of your move to Polaris Industries in order to continue your warranty coverage. You may also be required to obtain documentation from Polaris Industries in order to register your vehicle in your new country.

How to Get Service

If Purchased From A Private Party:

If you purchase a Polaris product from a private citizen outside of the country in which the vehicle was originally purchased, all warranty coverage will be denied.

Notice

If your vehicle is registered outside of the country where it was purchased, and you have not followed the procedure set out above, your vehicle will no longer be eligible for warranty or service bulletin coverage of any kind. (Vehicles registered to Government officials or military personnel on assignment outside of the country where the vehicle was purchased will continue to be covered by the basic warranty.)

For questions call Polaris Customer Assistance:

United States: 1-763-417-8650

Canada: 1-204-925-7100

INDEX

A

Accessories	64
Adjustments	73-85
Age Restrictions	8
Air Filter	86
Auxiliary Brake	38, 75

B

Battery	96-98
Battery Charging	97-98
Battery Installation	96
Battery Removal	96
Battery Storage	97, 102
Brake Lever	36
Brakes	35, 75
Break-In Period	44-45

C

Camber and Caster	77
Carburetor	79
Choke	39
Chrome Wheel Care	102
Cleaning and Storage	99-102
Cleaning the ATV	99
Clutching Chart	105
CONTROLS	32-43
Corrosion, Removing	102
Cylinder Head/ Cylinder Base Fastener	83

D

Drive Chain	83
Driving Downhill	54
Driving in Reverse	59
Driving on Slippery Surfaces	51
Driving Over Obstacles	58
Driving Procedures	49
Driving Safely	49-62
Driving Through Water	56-57
Driving Uphill	52

E

Electrical Switches	32
EMISSION CONTROL SYSTEMS	63
Engine Fogging	101
Engine Oil Check	71
Equipment Modifications	12

F

FEATURES	32-43
Filter Systems	86
Front Wheel Hub Tightening	82
Fuel Filter	39
Fuel Safety	40
Fuel Stabilizer	100
Fuel Tank	39
Fuel Valve	39

G

Gear Selector	42
---------------	----

H

Handlebars	78
Hauling Cargo	60-61
Headlight Adjustment	88
Headlight Lamp Replacement	87

I

Indicator Lamp Replacement	89
Indicator Lights	34

J

Jetting Chart	105
---------------	-----

K

K-Turn	55
--------	----

L

Light Switches	34
Lights	87-89
Lubricants, 2-Cycle	70
Lubrication Recommendations	69-72

M

Main Switch	32
MAINTENANCE AND LUBRICATION	64-102
Maintenance Record	68
Making Turns	50

N

Noise Emission Control System	63
-------------------------------	----

INDEX

O

Oil	70
Oil Injection Tank	41
Oil Pump Adjustment	74
Oil Pump Bleeding	73
OPERATION	44-62
Operator Safety	8-27
Override Switch	32

P

Parking Brake	37
Parking on an Incline	62
Periodic Maintenance Chart	64-67
POLARIS PRODUCTS	106
Pre-Ride Inspection	46
PVT Drying	95
PVT System	94-95

R

Rear Drive Chain Slack	84-85
Rear Spring	77
Recoil Housing	93
Recoil Starter	43

S

Safe Riding Gear	31
SAFETY	8-31
Safety Decals and Locations	28-30
Safety Training	8
Sidehilling	53
Spark Arrestor	92
Spark Plugs	90
SPECIFICATIONS	103-105
Starting a Cold Engine	47
Starting a Warm Engine	48
Starting the Engine	47-48
Steering Assembly	77
Stop Switch	32
Storage Tips	100-102

T

TABLE OF CONTENTS	5
Taillight/Brakelight Lamp Replacement	89
Throttle Cable Freeplay	78
Throttle Lever	33
Tire Tread Depth	82
Toe Alignment	76
Transmission Gear Selector	42
Transmission Oil Change	72
Transmission Oil Check	72
Transporting an ATV	102
TROUBLESHOOTING	107-110
Turning Around a Hill	55

U

USFS Approved Spark Arrestor ...	63
----------------------------------	----

V

VEHICLE IDENTIFICATION NUMBERS	7
Vehicle Immersion	91

W

WARRANTY	111-113
Washing the ATV	99
Waxing the ATV	99
WELCOME	3
Wheel Installation	81
Wheel Nut Torque Specifications ..	81
Wheel Removal	80